

THE USE OF SEDIMENT PROFILE IMAGING (SPI) FOR ENVIRONMENTAL IMPACT ASSESSMENTS AND MONITORING STUDIES: LESSONS LEARNED FROM THE PAST FOUR DECADES

JOSEPH D. GERMANO¹, DONALD C. RHOADS², RAYMOND M. VALENTE³,
DREW A. CAREY⁴ & MARTIN SOLAN⁵

¹*Germano & Associates, Inc., 12100 SE 46th Place, Bellevue, WA 98006, USA*
E-mail: joe@remots.com

²*22 Widgeon Road, Falmouth, MA 02540, USA*
E-mail: Drhoads@aol.com

³*Germano & Associates, Inc., 902 Riverview Place, St. Marys, GA 31558, USA*
E-mail: rvalente@tds.net

⁴*CoastalVision LLC, 215 Eustis Avenue, Newport, RI 02840, USA*
E-mail: coastal.vision@verizon.net

⁵*Oceanlab, University of Aberdeen, Main Street, Newburgh, Aberdeenshire, AB41 6AA, UK*
E-mail: m.solan@abdn.ac.uk

Abstract Sediment profile imaging (SPI) technology has been used in some form since 1969 to investigate the structure and appearance of near-surface aquatic sediments. The recognition of patterns in images and their relationship to seafloor processes mediated by biological, physical and chemical interactions was pioneered by academic scientists interested in sedimentary structures and evidence of biological communities in the geological record. The application of SPI technology to environmental assessment coincided with the development and testing of a robust theory of marine benthic community responses to disturbance in fine sedimentary habitats. The patterns visible in the images of seafloor sediments were related to processes associated with the recolonization of disturbed fine sediments through manipulation experiments and field observations. Association of these patterns with stages in the recovery of disturbed habitats provided the basis for SPI as a tool for environmental assessment and monitoring surveys. After almost 40 years of application of SPI technology to environmental assessment and monitoring, we are in a position to summarize the strengths and weaknesses of this technology. This review describes the history of instrument development and image interpretation, discusses the technical limitations and advantages of the method, summarizes the range of applications of SPI technology, and considers possible future directions for the technology, supporting theory, and application.

Introduction

Sediment profile imaging (SPI) was developed by Donald Rhoads and his colleagues at Yale University in the late 1960s. Although the origins of SPI lie in academic studies of both animal-sediment relations (Rhoads & Young 1970, Young & Rhoads 1971) and sedimentology (Bokuniewicz et al.

1975), Rhoads and his colleagues soon realized the advantages of the technology for documenting gradients in physical, chemical, and biological properties of the seafloor (Rhoads & Germano 1982, 1986). While conventional underwater photography failed miserably in estuarine settings because of the typically high turbidity in the water column, SPI provided researchers with clear images of the sediment profile due to its unique design, allowing investigators to take 'optical cores' of aquatic sediments much more rapidly and efficiently than using traditional sampling methods (grabs, box cores, piston cores, etc.). The cost-effectiveness of the methodology (both in sample acquisition and data return) soon attracted the interest of agencies responsible for monitoring anthropogenic impacts on the seafloor. The first applied work, undertaken for the New England Division of the U.S. Army Corps of Engineers (USACE), involved mapping the 'footprint' of dredged material deposited at designated disposal sites in New England estuaries and documenting the rate and mode of ecological recolonization of these deposits (Germano 1983a).

In the ensuing four decades since the first handheld profile camera was developed (Rhoads & Young 1970), SPI has been used to map physical, biological, and chemical/nutrient gradients in benthic habitats in a diverse array of freshwater and marine environments throughout the United States, as well as in a wide variety of international settings (e.g., Rhoads & Germano 1982, 1986, 1990, Boyer & Shen 1988, Diaz & Schaffner 1988, Rumohr & Schomann 1992, Valente et al. 1992, Rosenberg & Diaz 1993, Bona et al. 1994, Bonsdorff et al. 1996, Nilsson & Rosenberg 1997, Wright et al. 1997, Rosenberg et al. 2000, Keegan et al. 2001, Karakassis et al. 2002, Badino et al. 2004, Diaz 2004, Valente & Cuomo 2005, Birchenough et al. 2006, Teal et al. 2009). In addition to monitoring applications related to dredging and dredged material disposal (Germano 1983a, Nichols et al. 1990, Valente et al. 1999, Valente 2004, 2006, Birchenough et al. 2006, Wilson et al. 2009), other routine applications of the profile camera have included

1. Reconnaissance mapping to characterize gradients in seafloor conditions and develop the most efficient sediment grab or coring sampling design for both research and applied monitoring programmes (Germano et al. 1989, Rumohr 1995, Rosenberg et al. 2003a, 2004, Rosenberg & Nilsson 2005, Strayer et al. 2006)
2. Sediment quality or benthic habitat mapping (BHM) surveys in harbours and embayments (Valente et al. 1992, Diaz et al. 2003, Valente 2004, Bona 2006, Wilber et al. 2008)
3. Impact assessment studies for areas affected by eutrophication or low dissolved oxygen (SAIC 1987, 1988, Rhoads et al. 1991, Schaffner et al. 1992, Rosenberg et al. 1992, 2001, 2002, Diaz et al. 1993, Rosenberg & Diaz 1993, Nilsson & Rosenberg 1997, 2000, Valente & Cuomo 2005)
4. Effects assessment of aquaculture, offshore oil drilling, oil spills, or coastal municipal discharge (O'Connor et al. 1989, 1991, Rumohr & Schomann 1992, Diaz et al. 1993, 2008, Germano 1995, Rhoads 1995, Makra et al. 2001, Karakassis et al. 2002, Carroll et al. 2003, Wildish et al. 2003, 2004, Mulsow et al. 2006, Callier et al. 2008)
5. Defining the extent and nature of impacts due to anthropogenic activities such as coastal paper/pulp mill facility discharges, sand mining, trawling, cable and pipeline installation, and log transfer facilities (Ball et al. 2000, Germano & Read 2002, Nilsson & Rosenberg 2003, Rosenberg et al. 2003b, Smith et al. 2003, Germano & Browning 2006, Germano & Associates 2010)

SPI has also been used for a variety of academic research applications, including the observation of animal-sediment relations (Germano 1983b, Boyer 1985, Schaffner 1990, Grehan et al. 1992, Diaz et al. 1994, Cutter & Diaz 2000, Solan & Kennedy 2002), the quantification of gastropod sex ratios (Kennedy 1995), the study of porewater dissolved oxygen and electrochemical potential (Eh) (Glud et al. 2001, Diaz & Trefry 2006) as well as deep-sea Antarctic sediments (Howe et al. 2004, 2007, Brandt et al. 2007), predation and benthic trophic dynamics (Nestlerode & Diaz 1998, Josefson et al.

2002), studies of bioturbation (Solan et al. 2004b, Solan & Wigham 2005, O'Reilly et al. 2006b, Teal et al. 2008, Teal et al. 2009), infaunal succession (Rumohr et al. 1996, Rosenberg 2001), hydrodynamic processes (Rosenberg 1995) and biodiversity futures (Solan et al. 2004a), plus the role of biodiversity in ecosystem processes (Godbold & Solan 2009). While there were fewer than a dozen sediment profile cameras in academic research institutions worldwide at the turn of the century, an increasing number of investigators have acquired and incorporated this technology in their work over the last decade. Most work has been performed in marine or estuarine habitats, although some freshwater work has taken place (Boyer & Shen 1988, Boyer & Hedrick 1989, Boyer & Whitlatch 1989, Strayer et al. 2006). Profile cameras have explored benthic conditions around the world in water depths ranging from the shallow subtidal to the continental shelf, slope, rise and abyssal plain, with results from these various surveys presented in over 300 reports or publications. At the time of writing, more than 60 publications have appeared in peer-reviewed journals (Thomson Reuters Web of Science, search term topic "sediment profile imag*", to January 2011), while the majority are in the 'grey' literature, particularly in reports to clients (mostly government agencies) that describe profile camera monitoring results in relation to dredged material disposal impacts, organic enrichment, mariculture, sand mining, wastewater discharge and other effluents, seafloor drilling, and so on. About 80% of the work has been conducted in temperate environments, 11% in tropical or subtropical environments, and 4% in subpolar to polar waters (see citations). Much of the grey applied literature is difficult to access, with the exception of a long-term series of dredged material disposal site monitoring studies performed for the Disposal Area Monitoring System (DAMOS) programme for the USACE, New England Division (Fredette 1998). Sediment profile camera monitoring for DAMOS has the longest applied history for a single region, starting in about 1982 and continuing to the present, with all monitoring reports available for download on the Internet (<http://www.nae.usace.army.mil/damos/reports.asp>).

Intent of SPI review

SPI was originally introduced as a rapid, reconnaissance mapping tool to survey benthic habitats and interpret impacts to benthic substrata (Rhoads & Germano 1982, 1986); while some of the data available from profile images overlap those provided by traditional sediment sampling (e.g., sediment grain size major mode and range), SPI was initially developed to supplement and direct traditional grab or box core sampling, not to replace it. In addition to being an efficient means of locating a parsimonious subset of stations for traditional sediment or taxonomic analysis, the profile camera also provides valuable information on benthic processes (bioturbation, oxygen dynamics, nutrient biogeochemistry, trace metal cycling, sediment transport, geotechnical properties) within the context of site-specific abiotic and biotic processes (e.g., Godbold & Solan 2009, Teal et al. 2010). As with other aquatic acoustic and optical survey methodologies, SPI technology represents a type of remote sensing, and all remote sensing techniques benefit from 'ground truthing' (Hampson 1987, Grizzle & Penniman 1991, Rumohr & Karakassis 1999, Hyypä et al. 2000, Rosenberg et al. 2001, Diaz & Trefry 2006, O'Reilly et al. 2006a, Shumchenia & King 2010, Teal et al. 2010). While there have always been questions about the comparability or compatibility between SPI data and those provided by traditional taxonomic methods, it is important to emphasize that the use of SPI has never been viewed as an alternative to any other methodology or approach. Indeed, the characterization of benthic habitats with SPI has generally been accepted as an appropriate approach for verifying the remote acoustic characterization of seafloor habitats (Germano et al. 1989, Wildish et al. 2004, Valente et al. 2007) or suspended sediment transport models (Germano et al. 2002), and as this review demonstrates, the technique has also made valuable contributions to many other studies of small-scale processes, such as bioturbation and the infaunal mediation of ecosystem functioning (Solan et al. 2004a).

With the considerable volume of SPI experience gathered from around the world over the past four decades, we are now in a position to summarize the strengths and weaknesses of this technology.

The comparability of SPI results with those from traditional grab-sampling methods are addressed elsewhere (Germano et al. in preparation), but it is our intention to stimulate discussion by describing the history of development and interpretation of sediment profile images ('History'), evaluating the technical limitations and advantages of recent camera designs ('SPI technology: advantages and disadvantages'), summarizing the range of applications of SPI technology ('Review of historical applications'), and finally considering where we see the maximum future potential for SPI technology, theory, and applications ('Future directions').

History

Although SPI technology is primarily used today in marine and freshwater ecological studies, the earliest application of SPI was rooted in paleoecology and sedimentology. From 1965 to 1985, Donald Rhoads's laboratory in the Yale Department of Geology-Geophysics specialized in paleoecologic reconstruction of Paleozoic benthic environments. The unit of observation and measurement was usually a vertical cross section of sedimentary rock showing the relationship of fossils to their enclosing sedimentary matrix, especially the ancient sediment surface as manifested in a bedding plane. This early paleoecologic work suffered from a lack of understanding of animal-sediment relationships in modern marine sediments. At that time, methods of sampling modern-day organisms and their associated sediment involved grab or anchor dredge sampling. This type of physically disruptive sampling destroyed the *in situ* animal-sediment relationships that Rhoads and his students were interested in observing. A new approach was needed for *in situ* observation and study that left the vertical structure of the sediment strata and the distribution of the infauna relatively undisturbed.

Prototype cameras

To study undisturbed organism-sediment relationships in modern sediments in vertical cross section, Rhoads first constructed a simple profile imaging system consisting of a Nikonos 35-mm film camera and flash attachment mounted on a Plexiglas prism (Figure 1). The camera and prism were pushed vertically into soft substrata by a scuba diver, as described in several early publications (Rhoads 1970, Rhoads & Young 1970, 1971, Young & Rhoads 1971). After running out of air deploying the handheld camera in 110 ft of water in the centre of Cape Cod Bay, Rhoads developed a prototype vessel-deployed camera system (Figure 2) that was both safer and more efficient (Rhoads & Cande 1971). This system was built around a Rolleiflex 3.5f camera using 120 format film.

The lighting design in the camera prism was reconfigured in the late 1970s after Joe Germano arrived at Yale to study in Rhoads's lab. Together they developed the theory of image interpretation that led to a landmark article (Rhoads & Germano 1982). This article formally launched the technology and associated image products as Remote Ecological Monitoring of the Seafloor, or REMOTS®. This trademark acronym was registered with the U.S. Patent and Trademark Office in 1983 and subsequently sold to the consulting firm Science Applications International Corporation (SAIC). In early SPI work carried out by non-SAIC entities, the technique was referred to as sediment profile imaging (SPI) to avoid trademark infringement. Trademark protection subsequently lapsed in 1993, and an informal agreement is in place to allow unrestricted cooperative peer development of the technology. Hence, the terms REMOTS and SPI are used somewhat interchangeably to describe the same basic methodology, but in recent years SPI has become the favoured acronym.

The design of the original vessel-deployed camera system had several limitations that needed correction: film for the Rolleiflex camera was available in only 12- or 24-exposure rolls, and the camera housing was only watertight to a depth of 100 ft. In 1983, the system was redesigned by ocean engineers at Benthos, Incorporated, in North Falmouth, Massachusetts, a world leader in underwater optical systems and equipment (Figure 3). This new system was built around a standard commercial

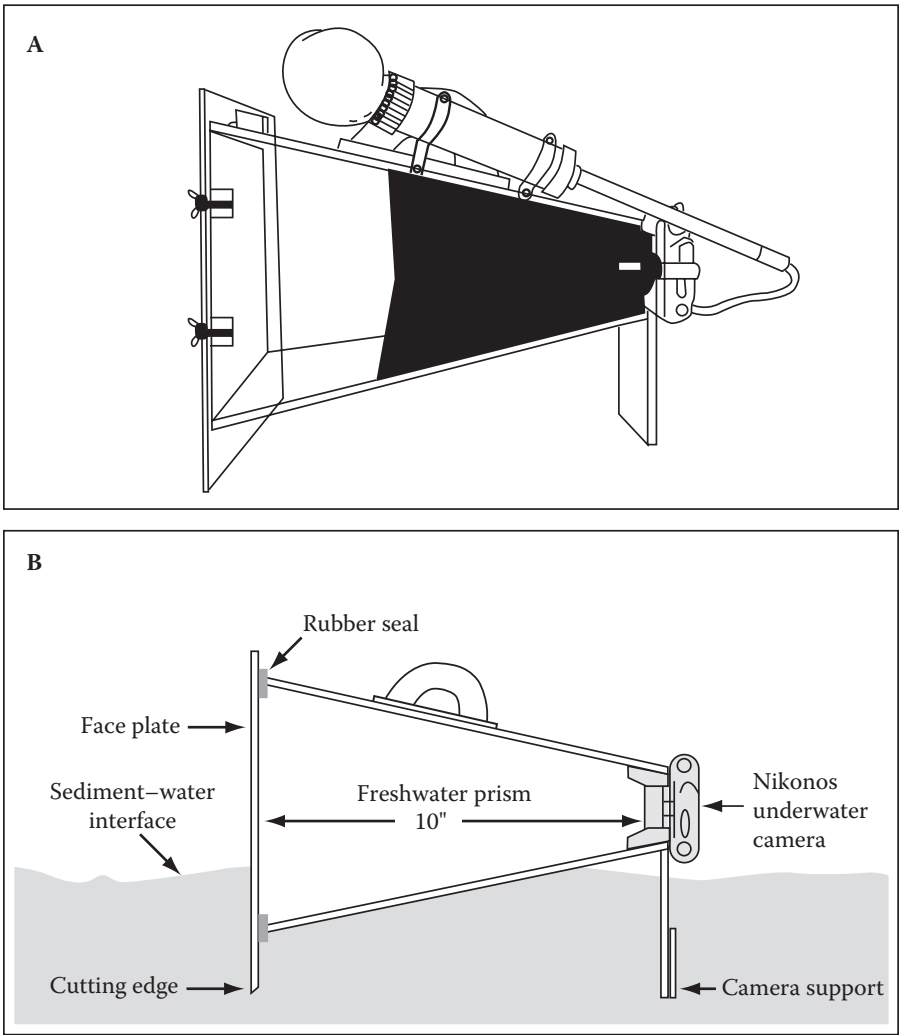

Figure 1 Schematic of the original sediment profile camera. (A) Lateral view showing the Plexiglas pyramid attached to a Nikonos underwater camera. (B) Cross section showing the camera placed in position by a diver to photograph the sediment surface in profile. (From Rhoads & Young 1970. Reprinted with permission from *Journal of Marine Research*.)

35-mm single-lens reflex (SLR) camera (easily replaced in the field if problems occurred) and depth rated to 4000 m. In 1996, the 35-mm SLR camera was replaced with the internal hardware from a Benthos Model 371 deep-sea camera so that a 50-ft bulk film cassette could be used instead of a standard 36-exposure roll of film used in SLR cameras. This eliminated the need for frequent film changes that delayed field operations because of the time involved with opening and resealing the housing along with controlling the high degree of internal condensation that occurred as a result of the temperature difference between the camera and the ambient air on deck. In 2002, the Benthos camera line was purchased by Ocean Imaging Systems of North Falmouth, Massachusetts (<http://www.oceanimagingystems.com>), and the camera was redesigned once more with a digital SLR camera and a through-housing, watertight USB (universal serial bus) connection for downloading images immediately on retrieval without having to open the housing. A downward-looking digital camera system was also designed in 2005 to allow concurrent collection of a horizontal-plane

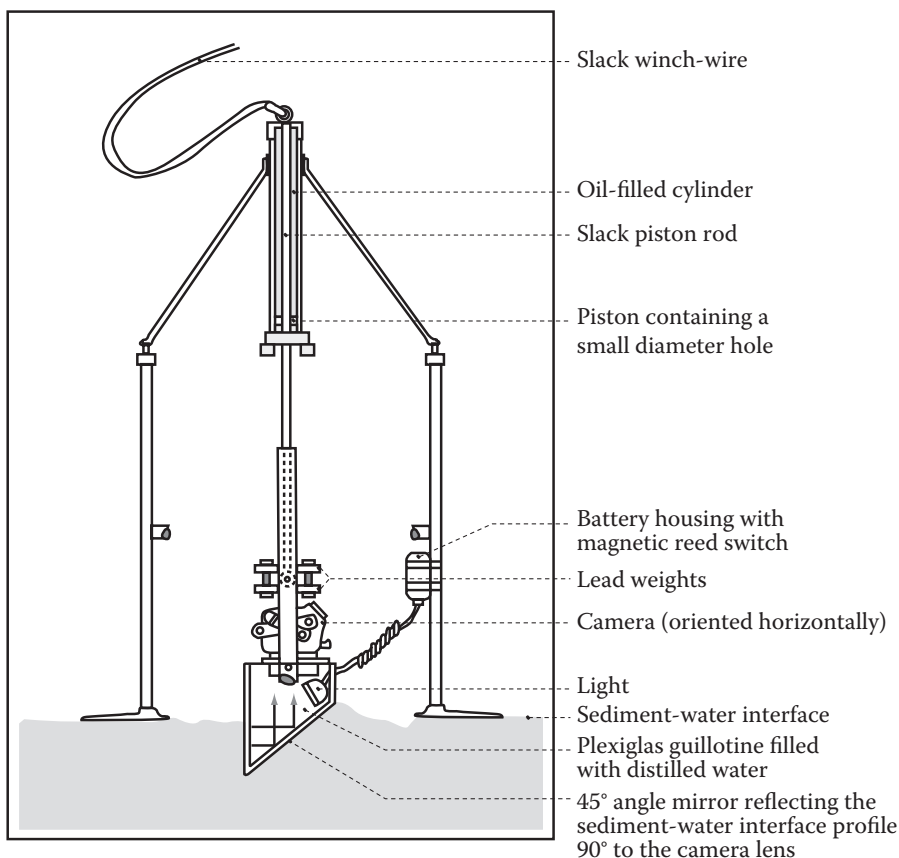

Figure 2 Schematic of the first vessel-deployed sediment profile camera showing the camera in the down position intersecting the bottom. (From Rhoads & Cande 1971. Copyright 1971 by the American Society of Limnology and Oceanography, Inc.)

(plan-view) image of the undisturbed sediment surface just prior to the landing of the SPI camera (Figure 4).

Early image analysis

The analysis of each profile image involves making a series of direct measurements (DMs) and visual estimates (VEs) for a number of parameters, such as the penetration depth of the camera (DM), sediment grain size major mode and range (VE), presence and thickness of depositional layers (DM), depth of the oxidized surface layer (DM), infaunal successional stage (VE), and presence/absence of surface and sub-surface biological features (DM). Image analysis is performed by trained analysts who directly view each image and make each measurement with the aid of interactive computer software. The process, therefore, is computer aided, but unlike some other types of image analysis, is not automated or batch processed and relies on operator input as well as skilled interpretation at key points in the analysis routine.

Early image analysis (ca. 1980) was done by tracing features on acetate overlays placed on an 8 × 10 enlarged black-and-white print of each profile image and then using a planimeter or digitizing tablet to measure areas of interest. While still a graduate student in Rhoads's lab, Germano launched an initiative to make the image analysis phase of SPI projects more efficient. Rhoads and Germano purchased one of the first commercially available image analysis systems tied to a personal computer. The system was manufactured by Measurionics Corporation of Great Falls,

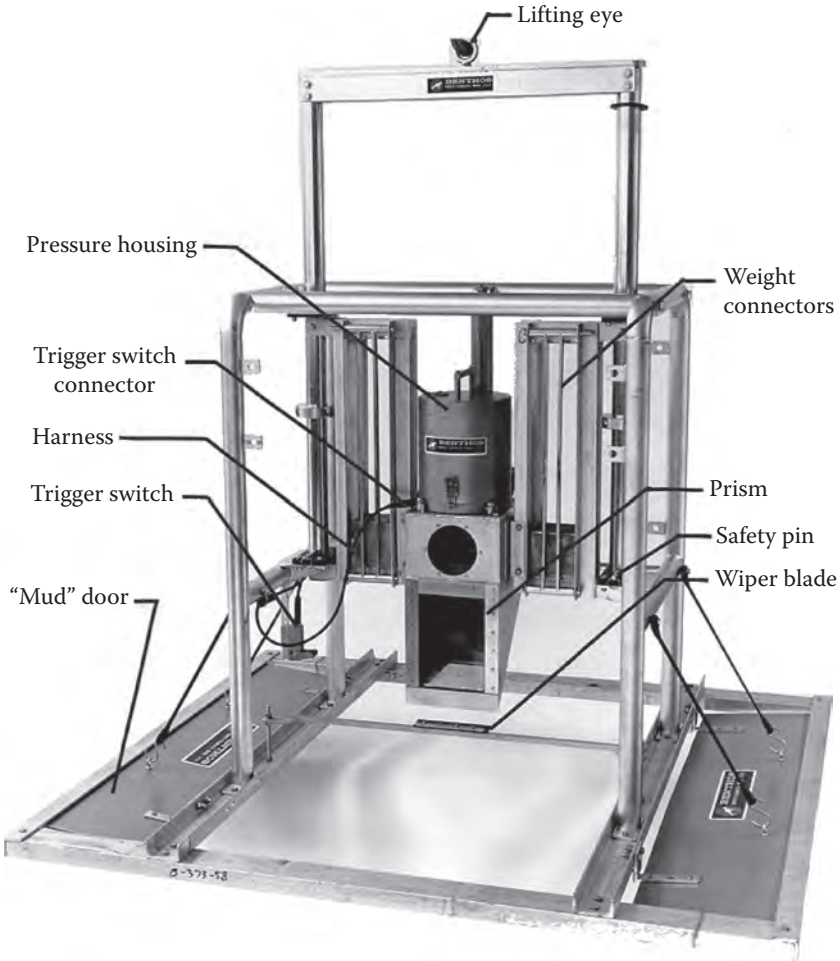

Figure 3 The deep-water (4000-m) Model 3731 sediment profile camera designed by Benthos, Inc., in 1983; note the wiper blade mounted on the base sled that will automatically clean the prism both on deployment and retrieval.

Montana, and had a video camera, frame grabber, and digitizer with an interface to an Apple II+ computer. Germano wrote the first software for making and recording digital measurements from black-and-white SPI negatives using a combination of 6502 Assembly Language and BASIC. This method of analysis and recording worked well for several years until more sophisticated analysis programmes for colour images became affordable and commercially available in the 1990s (Valente et al. 1992).

Interpretive models for imaged data

Two seminal articles published in 1978 provided the background for interpretation of sediment profile images in an ecological context. Both articles showed how organism-sediment relationships and macrofaunal succession were affected by organic enrichment (Pearson & Rosenberg 1978) or physical disturbance (Rhoads et al. 1978). Although the taxa of each benthic assemblage undergoing succession from the two independent studies were different (Sweden and Scotland versus New England), the patterns of spatial and temporal relationships were comparable and suggested that

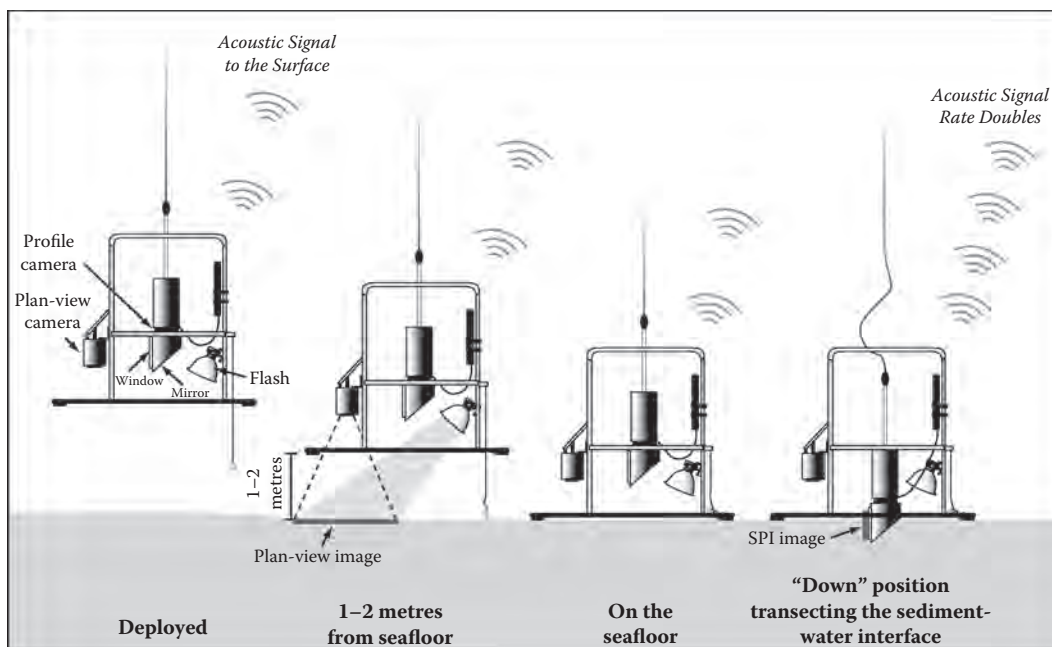

Figure 4 Schematic showing the operation of the current digital SPI system with associated digital plan-view camera.

the successional paradigm for soft-bottom benthic assemblages might be broadly applicable (see Snelgrove & Butman 1994 for counterargument). In addition, salient features of this phenomenological model could be imaged *in situ* and mapped using SPI, with results interpreted in the context of the successional models cited (Figure 5). Subsequently, the Pearson-Rosenberg-Rhoads framework was extended to other areas (e.g., the Baltic; Rumohr et al. 1996) and to freshwater systems (Soster & McCall 1990), allowing generic interpretation across a number of regions and ecosystems.

Another important publication that guided interpretation of sediment profile maps of benthic organism-sediment relations was R.G. Johnson's contribution (1972) on conceptual models of marine benthic communities. Johnson's work argued that "the (benthic) community is a temporal mosaic, parts of which are at different levels (stages) of succession. ... In this view, the community is a collection of the relics of former disasters" (later revisited and modified by Zajac 2001, p. 135). He also put forth the idea that studying spatial variation would allow one to approximate the order of community succession, and that earlier successional assemblages "prepare the way for later ones." Prophetically, he concluded that this conceptual model would have importance for future pollution studies.

SPI technology: advantages and disadvantages

Advantages

Preservation of animal-sediment relations

Because most humans rely on visual images for what constitutes their perception of reality, the real power of SPI is its ability to provide clear images of fine-grained aquatic sediments. This soft, muddy ecosystem occupies a large percentage of both marine and lacustrine systems and was previously unseen, especially in estuaries where water turbidity levels are high (for review, see Solan et al. 2003). Prior to the development of the sediment profile camera, investigators' perceptions of what existed on the muddy seafloor relied on photographs that showed relatively featureless surface

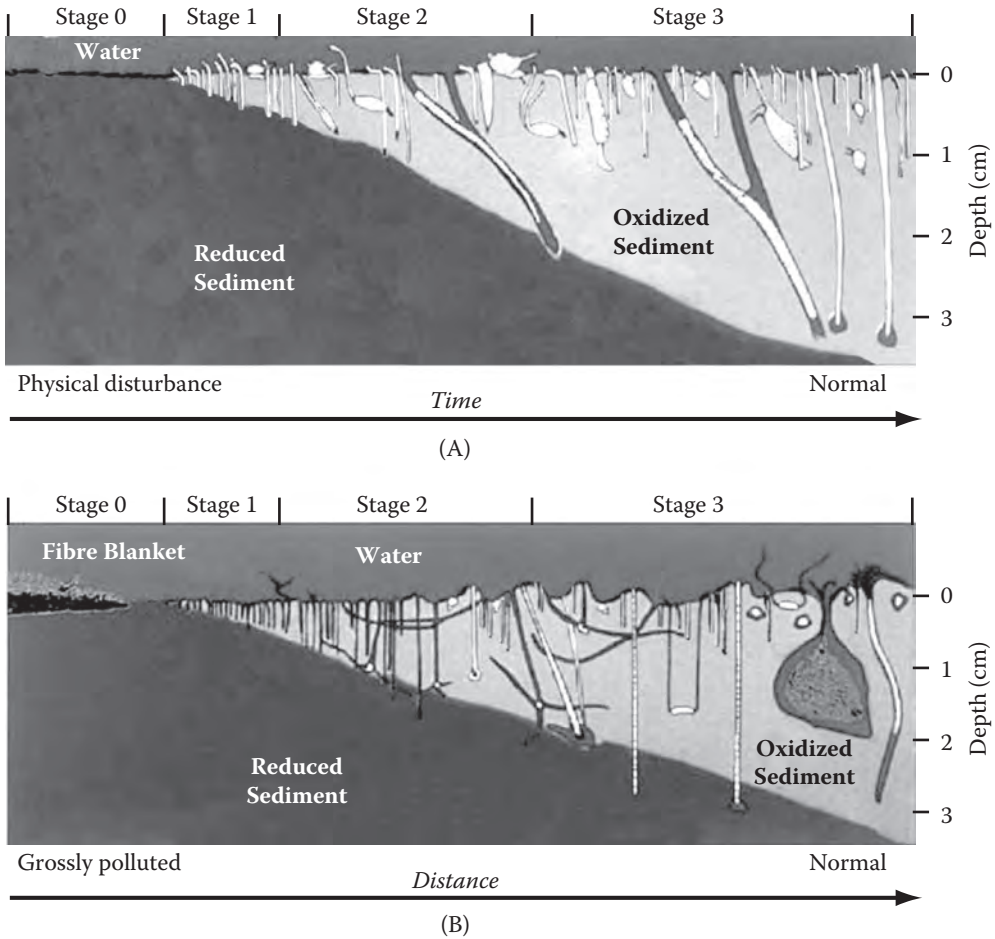

Figure 5 Soft-bottom benthic community response to (A) disturbance, or (B) organic enrichment. (From Rhoads & Germano 1982. Reprinted with permission from *Marine Ecology Progress Series*.)

images of muddy plains (when water turbidity levels were low enough to permit conventional underwater photography), historical drawings of benthic grab results (Figure 6; standard operating procedure between 1910 and 1965), X-radiographs, or the preserved contents of jars containing the sieved remains from grab samples. Sediment profile images not only provided investigators with a sharp, clear image of the sediment-water interface for the first time, but also the design of the camera provided a relatively undisturbed, cross-sectional image while preserving both animal-sediment relationships and other physical and biogenic features normally destroyed during grab sampling or grab processing. Indeed, in a study in the northern Baltic Sea, Bonsdorff et al. (1996) emphasized how SPI provided valuable additional information not available through traditional sampling methods; while grab samples documented the presence of amphipods, the profile images showed the importance of these amphipods to surface sediment reworking and nutrient remineralization. The ability of the profile camera to provide a clear image is without a doubt its most powerful attribute. The images, in turn, allow information on seafloor processes and organism-sediment relationships to be conveyed in a format that is easily understandable for regulators, managers and non-scientists (Figure 7). SPI images have proven to be a powerful communication tool on many occasions in a variety of controversial marine disposal or cleanup projects for which public meetings were part of the process (Germano 1994).

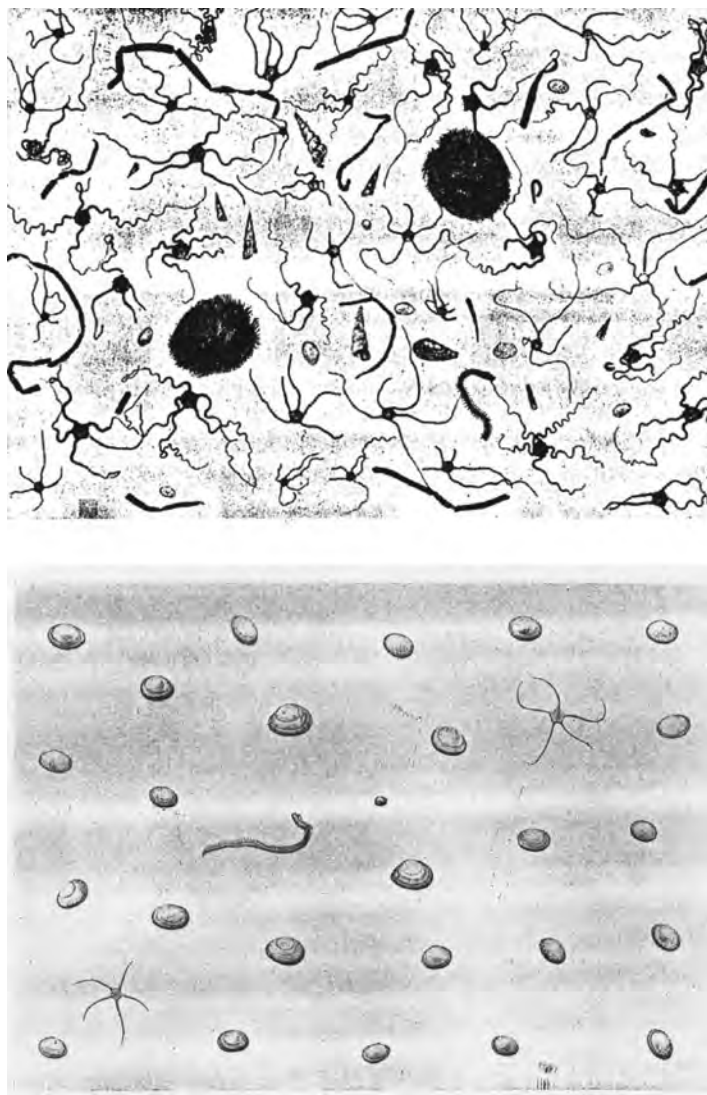

Figure 6 The results of benthic grab samples were carefully arranged on the same unit surface area sampled by a grab and drawn or photographed to give readers a sense of variation in species richness and abundance from one station to the next. (From Petersen. 1913).

Image quality not affected by water conditions

Another key advantage of the design of the camera is the independence of picture quality from ambient water clarity. Because the camera is always shooting through a pathway of distilled water, it can obtain perfect images of the seafloor in the most turbid estuaries, where conventional photography would fail miserably (Solan et al. 2003). Water depth also is not typically a limiting factor; the commercially available versions of the camera (Ocean Imaging Systems) are depth rated to either 1000 or 4000 m, and non-commercial (research) cameras have been built at the Oceanlab at the University of Aberdeen (<http://www.oceanlab.abdn.ac.uk>) that are depth rated to 8000 m, although difficulties in wire deployments at this depth have prevented use of the camera to its maximum capability.

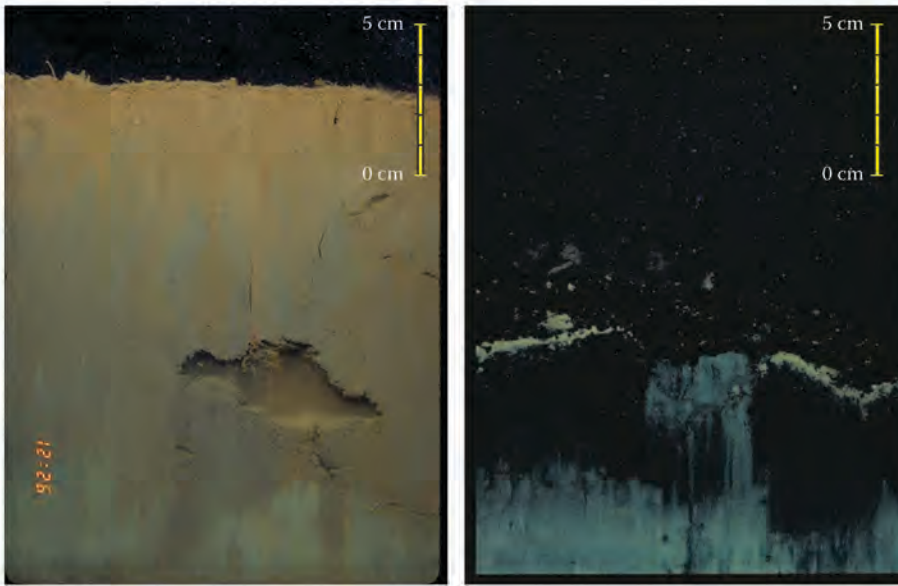

Figure 7 (See also Colour Figure 7 in the insert) These two sediment profile images from a healthy, undisturbed area and an organically enriched area with high sediment oxygen demand are excellent examples of how easily ecological information can be conveyed in a readily understood format.

Instrument versatility and sampling efficiency

The engineering and construction of the original Benthos camera design resulted in a robust instrument that is extremely reliable; some of the earliest models of the Model 3731 profile camera built in 1983 are still in operation today. Additional sensors (e.g., conductivity temperature depth (CTD), transmissometers, nephelometers, O₂ probes) or cameras (plan-view digital still or video) can be easily mounted on the basic SPI camera frame (Figure 4), so that multiple measurement tasks can be performed during a single camera deployment. Profile cameras have been modified for *in situ* sediment transport studies (Blanpain et al. 2009), to survey continuous swaths in a benthic ploughing device (Cutter & Diaz 1998), to study bioturbation during *in situ* time-lapse deployments (Diaz & Cutter 2001, Solan & Kennedy 2002), for fluorescence imaging to track faunal-mediated particle redistribution (Solan et al. 2004b), or to relate faunal activity to trace metal cycling within the field of view (Teal et al. 2009).

The design of the camera allows rapid, efficient sampling without the need to either supply power down the wire (allowing deployment from any vessel of opportunity) or bring the instrument back on deck after an image is taken. After an image is obtained from the initial lowering to the seafloor, the camera is then raised up about 2–3 m off the bottom to allow the strobe to recharge; a wiper blade mounted on the frame removes any mud adhering to the faceplate (Figure 3). The strobe recharges within 5 s, and the camera is ready to be lowered again for a replicate image. Surveys can be accomplished rapidly by ‘pogo-sticking’ the camera across an area of seafloor while recording positional fixes on the surface vessel, and typically anywhere between 100 and 250 images can be collected in a single day (depending on wire time as a function of water depth and the positioning efficiency of the vessel). The technology is ideally suited for use as a reconnaissance sampling tool to delineate gradients in sediment type, organic loading, or biological community structure; an initial survey of an area with the profile camera eliminates the need for blind grab or core sampling and allows the most parsimonious design for the more expensive traditional sediment-sampling tasks.

Disadvantages

Initial capital cost

The commercially available versions of the profile camera are not inexpensive; however, given their reliability and longevity, the costs are reasonable when amortized over the life of the instrument. Nevertheless, they are not currently at a price point at which they would be included as part of a university's standard sampling equipment pool. At the time of writing, costs for the commercial instruments ranged between US\$45,000 and US\$75,000 (shallow-water aluminium or deep-water stainless steel housing); current pricing is available from the manufacturer (Ocean Imaging Systems, North Falmouth, MA). There are less-expensive options for shallow-water work available for those with access to a machine shop (see Patterson et al. 2006).

Physical sampling constraints

The camera was designed to work in silt-clay to muddy-sand sediments. While additional weights can be added to increase the penetration in sediments that are either consolidated or have a higher fraction of sands, there is a point at which the profile camera provides little information other than sediment grain size and surface boundary roughness because of the limited prism penetration (Figure 8). In most well-sorted, sandy sediments, if there is a low percentage (<10%) of silt-clay particles and associated organics (e.g., as in the tropics or deep ocean), there is no significant colour change associated with redox gradients. Therefore, even if sands are well bioturbated so that the sedimentary fabric is diluted, the sediment shear strength is relatively low, and the camera prism can penetrate adequately (>8 cm), it is difficult, if not impossible, to determine the depth to which the sediment is mixed by physical or biological processes. Also, while the successional dynamics of invertebrate communities in fine-grained sediments have been well documented, the successional dynamics of invertebrate communities in sand and coarser sediments are not well known. Subsequently, the insights gained from SPI technology regarding biological community structure and dynamics in sandy and coarse-grained bottoms are presently limited. However, this particular constraint is not a limiting factor if the objective of a particular survey is to map sedimentary facies, and new camera designs aimed to increase penetration are emerging (e.g., dynamic sediment profile imaging (DySPI), Blanpain et al. 2009; rotational sediment profile imaging (r-SPI), Paavo 2007, Vopel et al. 2007).

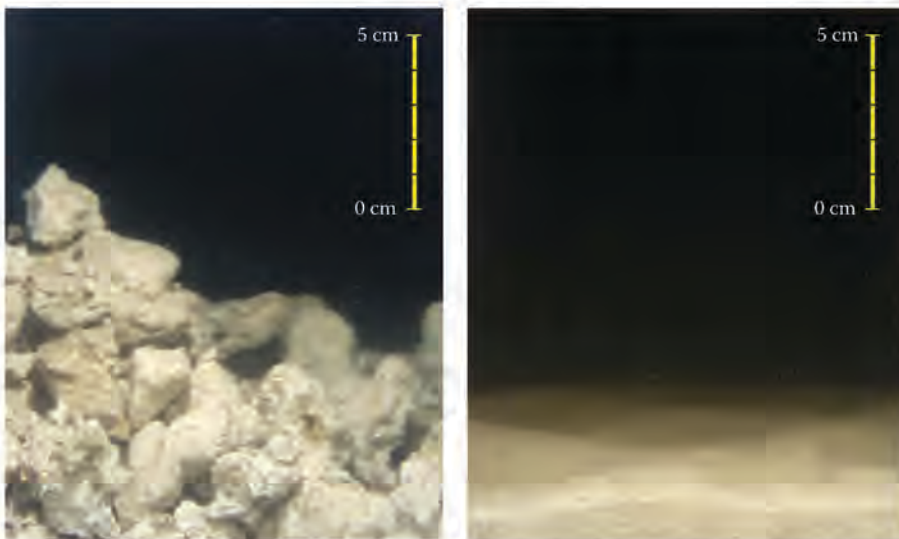

Figure 8 (See also Colour Figure 8 in the insert) These profile images are typical of the limited penetration and information gained as one moves into sandier, coarse-grained sediments.

Inability to generate species list or accurate faunal density counts

A commonly held misconception is that the use of SPI can provide a convenient substitute for sampling of invertebrate communities. While SPI is an invaluable aid that can help direct the efforts of traditional benthic sampling operations, if the objectives of a particular programme require information on infaunal species identification, biomass, or population densities, then investigators must use alternative methodology, such as grab or box core samplers to acquire those data. While the camera can be used as a reconnaissance mapping tool to help select grab-sampling locations or can substitute as a primary monitoring tool if it addresses the specific questions being asked by the monitoring programme design (Germano et al. 1994), it was never intended to replace traditional benthic sampling. Hence, commentary that highlights the inability of SPI to generate faunal information as a disadvantage is erroneous.

Standard methods for interpretation not readily available

In addition to the original articles that first outlined the theory of image interpretation (Rhoads & Germano 1982, 1986), some efforts have been made to standardize measurement of parameters and calculate indices of 'benthic habitat quality' (Rhoads & Germano 1986, Valente et al. 1992, Nilsson & Rosenberg 1997, Rosenberg et al. 1999, 2009, Diaz et al. 2004, Cicchetti et al. 2006, Shumchenia & King 2010). The interpretation of the ecological significance of subtle variations in sediment colour, texture, and pattern requires in-depth training in benthic processes, including geological, geochemical, and biological interactions, best acquired through techniques such as vertical dissection of box cores (Whitlach 1974). Not unlike the interpretation of geological features, interpretation of sediment profile images requires a skilled analyst who is knowledgeable about the processes at work on the seafloor and the patterns created by these processes. This requirement for skilled image analysts has limited the use of SPI technology to a relatively small group of experienced practitioners, and during the first two decades after the development and introduction of the technology, there were relatively few universities that had access to this technology or were training students. This situation is changing, however, as new faculty are being hired, and more universities and research laboratories are either acquiring the commercial units or building their own versions of the camera (Cutter & Diaz 1998, Patterson et al. 2006). This has led to recent efforts to interrogate both the image analysis methodology used (Solan et al. 2004b, Nammalwar et al. 2010) and the assumptions made during image interpretation (Teal et al. 2010), as well as the introduction and application of more sophisticated statistical techniques (e.g., Bekkby et al. 2008, Godbold & Solan 2009, Teal et al. 2009).

Review of historical applications

Since the development of the technology over four decades ago as a rapid reconnaissance tool for characterizing physical, chemical, and biological seafloor processes, the bulk of the applied SPI work has been in the field of dredged material disposal (e.g., Birchenough et al. 2006, Valente 2006, Wilson et al. 2009). These studies have covered all aspects of dredged material impact assessment, including baseline characterization for disposal site designation studies, sediment characterization at disposal sites, mapping the lateral extent and thickness of dredged material deposits on the seafloor, confirming the efficacy of contaminated sediment capping operations, and a variety of environmental assessment studies to monitor the recolonization of confined and unconfined aquatic disposal sites.

While it would be next to impossible to mention all the monitoring programmes and their results from the past 40 years for which SPI has played a key role, we highlight some of the significant representative projects and their findings in various applications for which SPI technology has proven to be an effective monitoring and assessment tool.

Dredged material monitoring

Background

The most extensive application of SPI over the past four decades has been evaluating the seafloor impacts of dredging and dredged material disposal in estuarine, near-coastal, and deep-water environments located throughout the United States and several international locations. This application has its roots in the late 1970s, when Rhoads and Germano's development of the first modern sediment profile camera and associated conceptual framework for image interpretation at Yale University in Connecticut coincided with heightened concerns about potential negative environmental impacts associated with the permitting by the USACE of dredged material disposal in the nearby waters of Long Island Sound. In 1977, the USACE responded to such concerns by initiating the DAMOS programme, which continues to the present day as the longest-running programme of its kind in the world. The DAMOS programme was established to address the many questions surrounding the environmental impacts of dredged material disposal at multiple open-water sites located throughout coastal New England (Fredette & French 2004).

Since 1977, together, the numerous DAMOS studies have served to provide the following:

1. Increased basic knowledge and predictive capability about the spatial distribution and long-term stability of dredged material deposited on the seafloor under different hydrodynamic regimes
2. Optimal strategies for selecting, monitoring, and managing disposal sites
3. Information concerning the potential for trophic transfer and bioaccumulation of chemical contaminants
4. Effective approaches to capping of contaminated sediments

The considerable insights gained from DAMOS studies, which have relied on SPI as a primary monitoring tool, have facilitated steady advancements not only in the approaches used to conduct the monitoring itself within a clearly defined framework for decision making (Fredette et al. 1990, Germano et al. 1994, Valente 2004) but also in the management of the entire dredged material permitting and disposal process (Fredette 1998, Fredette & French 2004).

SPI monitoring of dredged material disposal impacts

Prior to the advent of SPI, grab sampling was the main technique used to evaluate impacts of dredged material disposal on benthic communities. During the earliest days of the DAMOS programme, SPI proved extremely useful for addressing some of the most pressing early questions about the spread of dredged material on the bottom, its effects on resident benthic communities, and the rate of benthic community recolonization. In addition, SPI was recognized for its superior time- and cost-efficiency: 100–200 images day⁻¹ from upwards of 40 or more SPI stations at disposal sites in Long Island Sound and coastal New England (water depth range ~30–100 m), with data reports produced within a few days to a few weeks.

Because of its successful use under the DAMOS programme and other dredged material monitoring projects, SPI became one of several techniques recommended in USACE guidance documents for routine use in dredged material disposal site designation, monitoring or capping studies (Fredette et al. 1990, Pequegnat et al. 1990, Palermo et al. 1998). SPI has been employed in such studies on the coasts of the United States and several overseas locations (Table 1). This work has been conducted primarily by private-sector consulting companies under contract to government regulatory agencies. Therefore, it is documented mainly in technical reports, conference proceedings, or journals with a marine engineering focus (Germano & Rhoads 1984, Revelas et al. 1987a, Germano et al. 1989, Rhoads & Germano 1990, Fredette 1998, Valente et al. 1999, Valente & Fredette 2002, Valente 2004). There is a notable gap in the mainstream marine ecological literature

Table 1 Major programmes or projects for which SPI has been utilized for dredged material disposal site designation studies, monitoring of open-water disposal impacts, or evaluation of the efficacy of contaminated sediment capping

Programme/ project name	Main sponsor(s)	Study dates	Synopsis	Example publications
Disposal Area Monitoring System (DAMOS)	USACE–New England District	1977–present	Regular monitoring at open-water disposal sites, coastal New England, USA	Fredette & French 2004, Valente & Fredette 2002, Germano et al. 1994, Germano & Rhoads 1984, Wilson et al. 2009
Monitoring at the Historic Area Remediation Site (HARS)	USACE–New York District	1986–present	Periodic assessments of disposal impacts and remediation activities at the former Mud Dump Site and at the existing HARS in the New York Bight, USA	Greges 1994, McDowell et al. 1994, Valente 1998, 2006, Valente et al. 1998b
Chesapeake Bay Dredged Material Disposal Site Monitoring	USACE–Baltimore District	1983–1992	Delineate dredged material deposits at designated sites and follow benthic recolonization in Chesapeake Bay, USA	Nichols et al. 1990
Thin-layer dredged material disposal in Mobile Bay	U.S. Army Corps of Engineers–Mobile District	1986	Assess environmental impacts of thin-layer dredged material disposal, Mobile Bay, Alabama, USA	Clarke & Miller-Way 1992
Washington Dredged Material Management Program (DMMP)	Washington State Department of Ecology/USACE– Seattle District	1988–present	Periodic monitoring at open-water disposal sites in the Puget Sound area, Seattle, Washington State, USA	Revelas et al. 1987a
San Francisco Deep Ocean Disposal Site (SF-DODS)	USEPA Region 9/ USACE–San Francisco District	1992–present	Delineate dredged material footprint and assess benthic recolonization at deep-water (3300 m) disposal site off San Francisco, California, USA	SAIC 1996, ENSR 2007
New Zealand Dredged Material Disposal Site Monitoring	Ports of Auckland	1992–1994	Follow dredged material dispersion and benthic recolonization at a disposal site in the Hauraki Gulf, NZ	Germano 1994, Gowing et al. 1997

(continued on next page)

Table 1 (continued) Major programmes or projects for which SPI has been utilized for dredged material disposal site designation studies, monitoring of open-water disposal impacts, or evaluation of the efficacy of contaminated sediment capping

Programme/ project name	Main sponsor(s)	Study dates	Synopsis	Example publications
Hong Kong Seabed Ecology Studies	Hong Kong Civil Engineering Department, Geotechnical Engineering Office, Fill Management Division	1993–2002	Assess ecological impacts of dredging and disposal at multiple sites throughout HK's territorial waters	Rhoads et al. 1995, Valente et al. 1996, 1998a, 1999
Massachusetts Dredged Material Management Plan (DMMP)	Massachusetts Office of Coastal Zone Management	1998–2004	Baseline surveys at candidate Confined Aquatic Disposal (CAD) sites and at an open-water disposal site in Buzzards Bay, Massachusetts, USA	Valente & Tufts 2001
Palos Verdes Shelf Capping Demonstration Project	USEPA Region 9/USACE–Los Angeles District	2000–present	Map the distribution of cap material and bioturbation of capped DDT-contaminated sediments off Los Angeles, California, USA	Fredette et al. 2002a, Valente et al. 2001
Monitoring at Licensed Disposal Site TY070, north-eastern coast of United Kingdom	U.K. Department for the Environment, Food and Rural Affairs	2001–2004	Evaluate acoustical and optical monitoring technologies for monitoring dredged material disposal sites in the United Kingdom	Birchenough et al. 2006

with respect to applied SPI work (exceptions include Birchenough et al. 2006 and Wilson et al. 2009). In recent years, many technical reports produced under regulatory programmes have become available in electronic format on the Internet. Also, a recent literature review described many projects and case studies for which SPI was used effectively, either alone or in combination with other seafloor mapping techniques, to evaluate the environmental impacts of dredging, open-water disposal, and contaminated sediment capping (Valente 2004).

We briefly summarize the two main applications of SPI technology for dredged material monitoring: (1) mapping the footprint of dredged material (for both unconfined and confined aquatic disposal projects) and (2) evaluating benthic recolonization after disposal operations have been completed.

Mapping the spatial distribution of dredged material The first use of SPI to map the spread, or footprint, of dredged material on the bottom traces back to the earliest days of the DAMOS programme, when resource managers lacked much of the basic information needed to address public concerns about far-field transport of dredged material and potential harm to living resources outside the designated boundary of each disposal site. One approach involved the use of sequential pre- and postdisposal bathymetric surveys. Precise control over the ship's position was achieved with a shore-based microwave system (prior to the advent of differential GPS) and relatively tight spacing (25–50 m) between the lanes traversed by the survey vessel. The resulting contour maps, using the technology of the time, were of sufficient resolution to reliably detect depth changes on the order of

± 0.5 m. Such changes usually occurred near the central apex region of a typical dredged material deposit or 'mound', where the main mass of dredged material had accumulated, directly beneath the single point at the surface (marked with a taut-wire moored buoy) where the disposal barges had repeatedly released the material.

The volume of dredged material detected by bathymetric surveys typically was markedly lower than the volume of material estimated to have been released at the buoy location, based on disposal barge log books. It was found that grids and/or transects of SPI stations could be used to detect and map the thinner layers of dredged material comprising the outer flanks or 'apron' of a typical disposal mound. These layers were too thin to be detected reliably using ship-based bathymetry and therefore were not accounted for by measuring depth differences from pre- and postdisposal surveys. The early DAMOS studies were instrumental in demonstrating for the first time that the mound flank or apron regions, detected and mapped using SPI, can account for over 90% of the seafloor area affected by disposal and over 45% of the total volume of disposed material (Germano 1983a, Germano & Rhoads 1984, Rhoads & Germano 1990).

Identifying dredged material and mapping its spatial distribution on the seafloor is predicated on the ability of SPI to discern differences, ranging from obvious to subtle, in a variety of characteristics that serve to distinguish the disposed sediments from those comprising the ambient seafloor in and around the disposal site. Among these characteristics are sediment colour, particle size, texture, small-scale surface roughness, apparent water content, and degree of cohesiveness. Figure 9 provides representative examples of different types of dredged material observed in SPI monitoring efforts in a variety of geographic locations. For comparative purposes, ambient seafloor conditions are characterized by collecting SPI images either from the planned placement site prior to the commencement of any disposal activities or, more commonly, from one or more nearby reference areas.

In addition to its unique optical or textural properties, dredged material placed at open-water sites will form single or multiple depositional layers on the seafloor, and these are often visible as distinct sedimentary horizons in profile images. Near the apex or central regions of disposal mounds, where the dredged material layers are relatively thick (on the order of several metres), the dredged material will occupy the entire cross-sectional area of sediment imaged by the profile camera (Figure 9A). As dredged material spreads out in ever-thinner layers away from the main central deposit, it can be viewed and measured as one or more discrete layers in profile images (Figure 9F).

The combination of precision bathymetry and SPI to accurately map the entire dredged material deposit on the seafloor (both the mound as well as the entire lateral extent of the flanks) is critical for successful sediment capping projects. Subaqueous capping is the controlled, accurate placement of contaminated dredged material at an open-water disposal site, followed by placement of a covering or cap of clean material to isolate the contaminants from the overlying water column and biota. Capping of contaminated dredged material at open-water sites began in the late 1970s, and numerous projects have since been completed (see multiple case studies presented in Palermo et al. 1998).

SPI has been utilized on capping projects in the following three ways: 1) immediately following dredging and placement of the contaminated sediment to delineate the full footprint of the material requiring capping (Germano 1983a); 2) following the placement of cap material to delineate the distribution and thickness of cap layers at the margins of the deposit and thereby verify complete coverage of the underlying contaminated sediment (McDowell et al. 1994); and 3) in post-cap monitoring to evaluate long-term cap integrity, typically in relation to concerns about cap disturbance from various physical and biological forces, such as waves, tidal currents, propeller-wash, and bio-turbation (Valente & Fredette 2002, Carey et al. 2010).

In capping studies, SPI is almost always used in combination with other sampling techniques, such as coring, bathymetry, side-scan sonar, and subbottom profiling. Among these, coring is employed most often to verify the full thickness of a cap, because most projects involve constructing a cap greater than 20 cm thick (the maximum vertical resolution of the majority of SPI cameras to date). Under the DAMOS programme, notable capping projects involving extensive use of SPI in

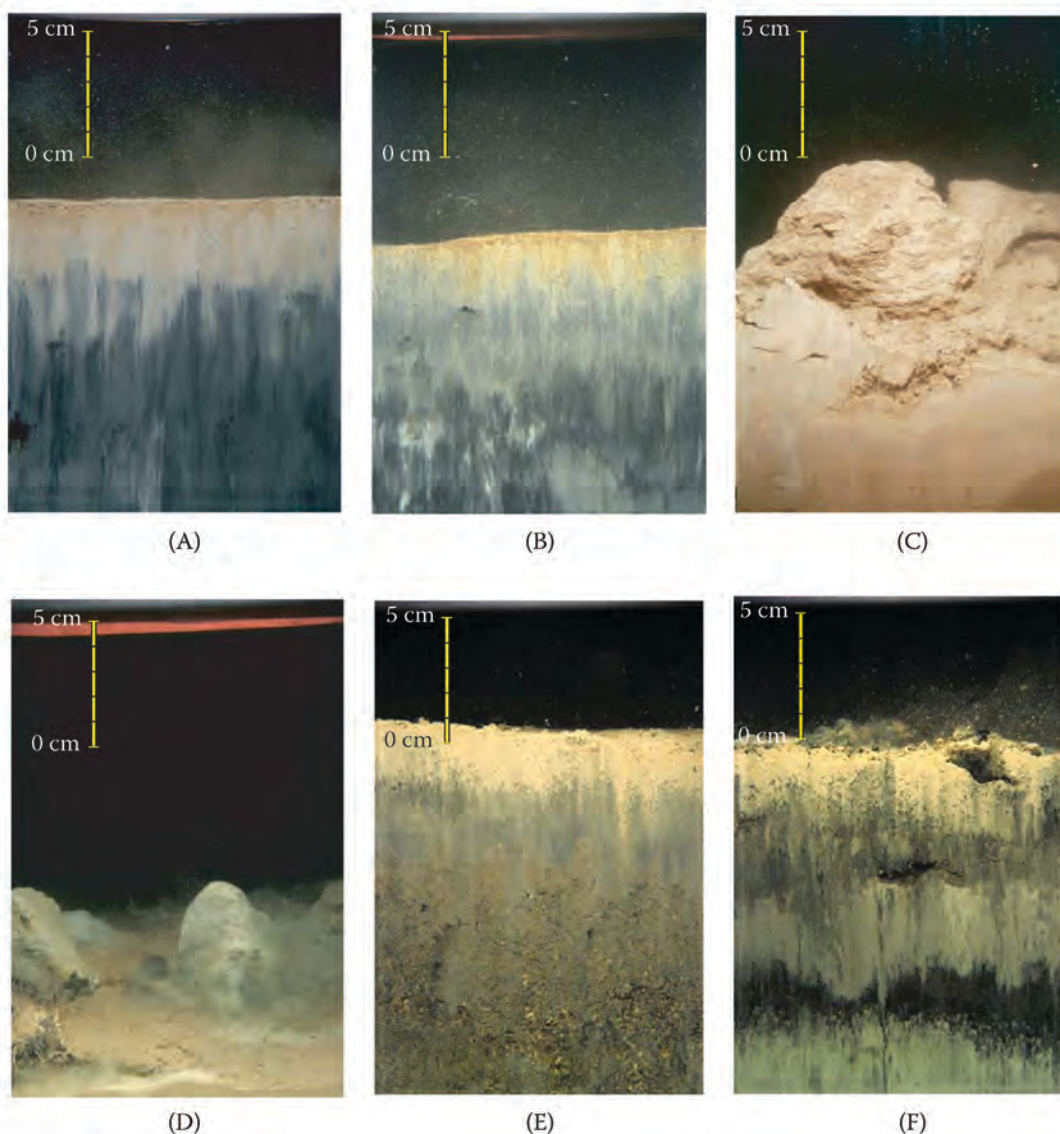

Figure 9 (See also Colour Figure 9 in the insert) Dredged material can vary widely in its appearance in sediment profile images: (A) Dredged material exhibiting highly sulphidic conditions (black colour) at depth below an oxidized surface layer. (B) Dredged material consisting of silt-clay with increasingly dark colouration at depth interspersed with whitish clay streaks. (C) Highly cohesive clumps of red clay placed at an offshore disposal site. (D) Cohesive grey clay clumps intermixed with brown silty sediment. (E) Dredged material deposit consisting of a silt-clay layer visible over a disposed layer containing a significant proportion of wood particles. (F) Multiple sand and silt-clay dredged material layers resulting from disposal during different seasons.

conjunction with other monitoring techniques include the Field Verification Program (FVP) project and several other pioneering capping projects at the Central Long Island Sound Disposal Site (Fredette et al. 1992, SAIC 1995, Carey et al. 1997), the Seawolf capping project at the New London Disposal Site in eastern Long Island Sound (SAIC 2001), the Brenton Reef ‘de facto’ capping project (Carey et al. 2010), experimental deep-water capping in 90 m depths at the Massachusetts Bay Disposal Site (SAIC 2003a), and a series of large confined aquatic disposal cells created as part of the Boston Harbour channel deepening project (Fredette et al. 2002b, SAIC 2003b). Beyond

DAMOS, SPI has been used to monitor sand cap creation and long-term integrity at several locations within the former Mud Dump Site in the New York Bight (McDowell et al. 1994), to evaluate benthic recolonization of back-filled borrow pits in Hong Kong (Valente et al. 1998a), and to evaluate effectiveness of capping at Los Angeles Harbour Pier 400 and the Puget Sound Naval Shipyard Confined Aquatic Disposal (CAD) cell in Bremerton, Washington State (Germano 2003).

Disposal operations carried out in the New York Bight illustrate how accurate SPI mapping of a dredged material footprint can play a critical role in successful capping operations. Dioxin-contaminated sediments had to be capped in 25 m of water at New York's Mud Dump Site in 1993 (Greges 1994, McDowell et al. 1994) and again in 1997 (Valente et al. 1998b). In both projects, management plans developed jointly by the USACE and the US Environmental Protection Agency (USEPA) required that the full footprint of the contaminated sediment dredged from container ship berths in Newark Bay, New Jersey, be capped with at least 1 m of clean sand (Greges 1994). Radial transects of SPI stations spaced at 25–50 m intervals were used to map the exact outer limit of the deposit and thereby helped managers make informed decisions about the amount and placement of the capping sand (Figure 10). Bathymetric surveys performed immediately following the sand placement activities confirmed that the goal of creating a uniform 1 m cap over the entire footprint of the contaminated sediment was largely achieved in both the 1993 and 1997 projects (Figure 10).

In each project, there was considerable concern over the long-term stability of the sand cap. Monitoring involving a combination of techniques (e.g., SPI, bathymetry, vibra-coring, side-scan sonar, and subbottom profiling) has been performed on a semiannual basis, and the last round of surveys conducted in 2002 (five to nine years, respectively, following the construction of each cap) showed that the 1 m thick layer of capping sand had remained intact (SAIC 2003c,d). The SPI images revealed that the surface of the cap has consistently been composed of rippled fine sand that appears to be regularly washed clean of fines by tidal currents. In this food-limited and shifting-sand habitat, a benthic community consisting of small, disturbance-tolerant, surface-dwelling suspension-feeders (Stage 1 community, Figure 5) has been dominant. The clean sand thus has been effective at discouraging colonization by the larger-bodied, deposit-feeding organisms (Stage 3, Figure 5) that are abundant in nearby areas where muddy, organic-rich dredged material has been placed (Figure 11). This limits the potential for such organisms to disrupt the integrity of the sand cap through deep bioturbation.

Using SPI to assess benthic community response to dredged material disposal The cross-sectional SPI images of the upper 20 cm of the sediment column efficiently monitor recolonization of dredged material after disposal operations have ceased (Figure 12). The phenomenological model (Rhoads & Germano 1982, 1986) used to aid the ecological interpretation of SPI images was first applied under the DAMOS programme to assess the ecological effects of dredged material disposal (Germano et al. 1994) and is still a useful paradigm for monitoring programmes in fine-grained sediments. In this approach, SPI surveys are conducted periodically at individual disposal mounds or sites and results compared with those from nearby reference areas. The SPI parameters of most interest in these comparisons are

1. The depth of the apparent redox potential discontinuity (aRPD), redefined as the mixing depth (*sensu* Teal et al. 2010), which reflects a combination of several site-specific environmental variables and can be detected based on the discrimination of sediment colour; oxidized ferric iron gives the surface sediment the red-brown colour in the presence of dissolved oxygen in the overlying water (Fenchel 1969, Lyle 1983).
2. Any evidence of organic enrichment as indicated by the presence of subsurface methane gas or extremely dark (sulphidic) sediment (Rhoads & Germano 1982, Bull & Williamson 2001).
3. The infaunal successional stage (Rhoads & Germano 1986).

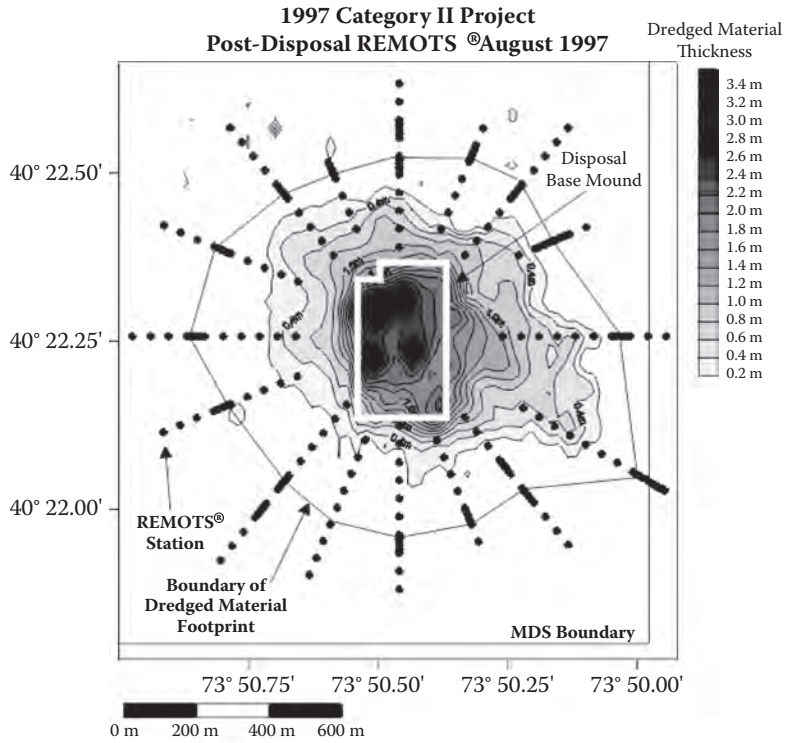

(A)

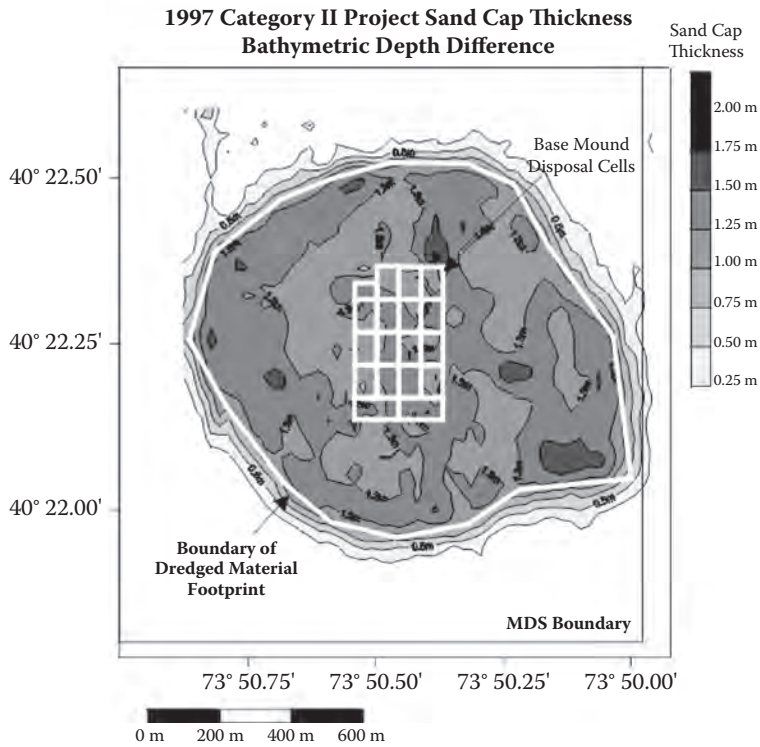

(B)

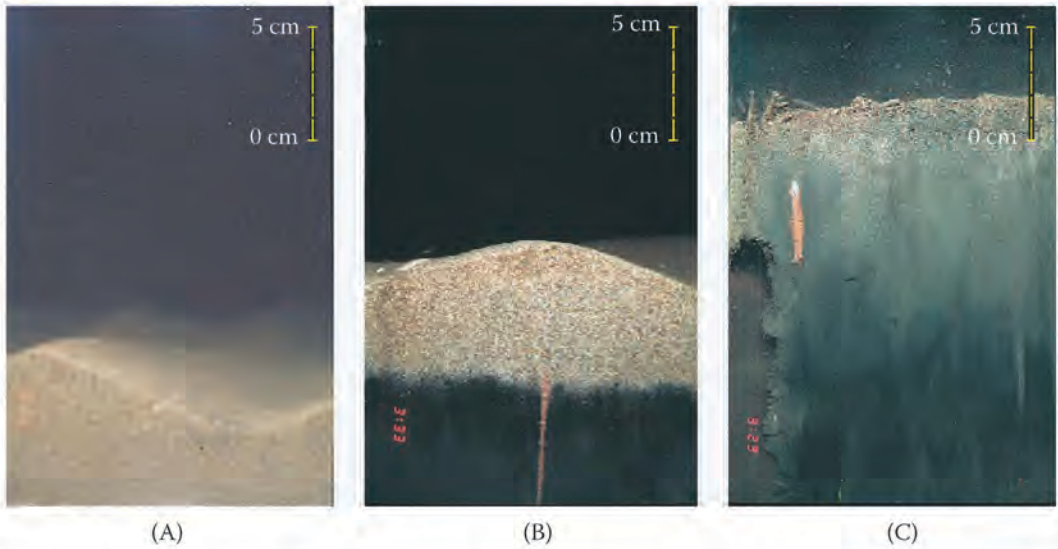

Figure 11 (See also Colour Figure 11 in the insert) Example SPI images from monitoring of capped dredged material disposal mounds at the former Mud Dump Site in the New York Bight. (A) Homogeneous fine sand dominated by small, surface-dwelling stage 1 organisms. (B) At the outer edge of the sand caps, a distinct stratigraphy is sometimes observed in which thinner layers of cap sand (ca. 5 cm in this image) are visible over fine-grained, historic dredged material. (C) Uncapped, fine-grained dredged material from past disposal activities occurs in the area surrounding the capped mounds supporting an abundant community of deposit-feeding, stage 3 organisms.

Figure 12 shows how these parameters vary relative to the conceptual model of infaunal succession following a physical disturbance such as disposal of dredged material.

Although the collation and statistical analysis of data from the grey literature has seldom been undertaken (e.g., Teal et al. 2008), the plethora of SPI surveys conducted worldwide across a wide range of disposal sites have confirmed the basic validity of this conceptual model (taking account of cautionary arguments about inferring causation from correlation; Snelgrove & Butman 1994), especially when applied to benthic colonization of fine-grained (muddy) sediment placed in a similarly fine-grained environment (the scenario at the majority of open-water dredged material disposal sites). Experience has shown that when muddy, organic-rich dredged material is first placed on the seafloor, it may be black (anoxic) or have only a thin (diffusional) oxidized layer at the sediment-water interface. Although the original publications of Rhoads & Germano (1982, 1986) did not explicitly identify this as a formal successional stage, in recent years this has been denoted as stage 0, indicating the absence of any visible macrofauna in the images (Figures 5 and 12A). Pioneering stage 1 assemblages that can appear within days to weeks after a dredged material disposal event typically consist of dense aggregations of near-surface, tube-dwelling, opportunistic polychaetes. Both the aRPD boundary and the maximal mixing depth attained through bioturbation in stage 1 assemblages may be relatively shallow, particularly in the earliest stages of colonization (Figure 12A,B).

Figure 10 (See facing page) Maps of the 1997 dioxin capping project at the former Mud Dump Site in the New York Bight. (A) Sequential bathymetric surveys in combination with SPI were used to determine the thickness and distribution of the dioxin-contaminated dredged material on the seafloor. Bathymetric depth differencing detected the thickest layers of dredged material near the mound centre, while transects of SPI stations were used to detect thinner layers of material on the mound flanks and thereby map the full dredged material footprint. (B) Following the capping operations, bathymetric depth differencing was used to confirm that the full footprint of dredged material had been covered with at least 1 m of clean sand.

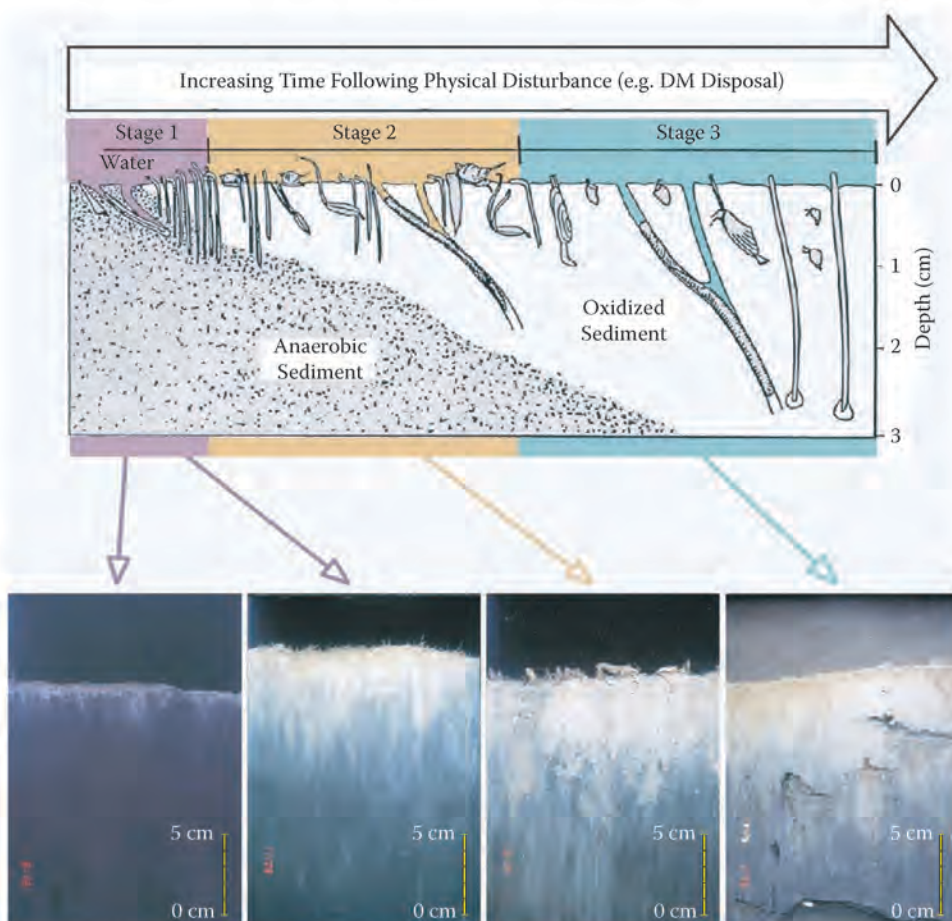

Figure 12 (See also Colour Figure 12 in the insert) The drawing at the top (from Figure 5) illustrates the development of infaunal successional stages over time following a physical disturbance. The SPI images below the drawing provide examples of the different successional stages. (A) Highly reduced sediment with a very shallow redox potential discontinuity (RPD) layer (contrast between light-coloured surface sediments and dark underlying sediments) and little evidence of infauna. (B) Numerous small polychaete tubes are visible at the sediment surface (stage 1) with a slightly deeper apparent RPD compared to the previous image. (C) A mixture of polychaete and amphipod tubes occurs at the sediment surface (stage 2). (D) Numerous burrow openings and feeding pockets (voids) at depth within the sediment are evidence of deposit-feeding, stage 3 infauna.

In the absence of further disturbance, the stage 1 assemblages are eventually replaced by infaunal deposit-feeders. The start of this infaunalization process is designated arbitrarily as stage 2. Depending on locale, this may or may not represent a distinct stage; tubicolous amphipods such as *Ampelisca* sp. and shallow-dwelling bivalves such as *Nucula* sp. and *Mulinia* sp. have been among the stage 2 organisms commonly observed in past SPI surveys of disposal sites located in temperate estuaries and near-coastal waters (Figure 12C). However, stage 2 may also be represented by juvenile recruits of species typically associated with the following stage 3 community. Stage 3 organisms are larger-bodied, infaunal, and typically found in low-disturbance regimes; many feed at depth in a head-down orientation that results in distinctive subsurface excavations, referred to as *feeding voids* (Figure 12D). Bioturbation by these deposit-feeders is responsible for the deepening

of the mixed layer, which can be located several centimetres below the sediment-water interface. A mature community dominated by stage 3 may require many months to years to become fully established, depending on the severity of the initial disturbance and the spatiotemporal structure of the species pool (following Zajac 2001).

SPI surveys conducted every few years test the hypothesis that as ecosystem recovery proceeds after cessation of disposal operations, aRPD depths will increase and benthic assemblages will eventually become comparable to those found at the reference areas. Evaluating the effects of dredged material disposal on the benthic habitat under U.S. dredged material monitoring programmes relies heavily on mapping aRPD depths and infaunal successional stages with SPI technology, and similar assessment schemes have been proposed in Europe (Rosenberg et al. 2004, 2009). Abnormalities in the expected infaunal successional sequence would then trigger additional investigations or conformity to regulatory thresholds.

Conclusion

The examples illustrate how SPI monitoring results have informed management decisions involving dredged material disposal management and capping programmes. The images have proven extremely powerful in allowing scientists, managers, and lay audiences to visualize over both space and time not only the physical habitat changes that have occurred as a result of disposal, such as changes in the grain size, texture, or oxidative (= functional) state of surface sediments, but also (and simultaneously) the *in situ* response of benthic organisms to the habitat changes (Godbold & Solan 2009). By mapping such data, major improvements in predictive physical disposal models as well as resource management capabilities have been made. SPI datasets from long-term dredged material monitoring programmes (Table 1) have demonstrated that at the majority of disposal sites, the sediment surface on dredged material disposal mounds eventually can be expected to return to predisposal or ambient seafloor conditions, but the timing can vary depending on a host of site-specific factors (type and quantity of dredged material, frequency of subsequent disturbance from events such as high-energy storms or near-bottom hypoxia, timing of disposal relative to seasonal benthic recruitment cycles, etc.).

Typically, SPI is employed as one of several seafloor characterization or BHM techniques for monitoring disposal and capping activities. In deciding which particular combination of techniques is most appropriate in a given situation, it is important that the study or monitoring programme objectives be articulated clearly at the outset. The overarching message of several valuable guidance documents (Fredette et al. 1990, Pequegnat et al. 1990, Palermo et al. 1998) is that seafloor mapping (or any other data collection activity) will not be effective unless it is done within a predefined decision-making framework that clearly identifies the questions asked as well as the management actions to be taken at each decision outcome.

SPI-based evaluations of benthic community response to dredged material disposal rely on application of a successional model developed for soft-bottom habitats (Pearson & Rosenberg 1978, Rhoads et al. 1978). Therefore, this technique has been useful for monitoring biological impacts at the majority of sites where both the dredged material and ambient sediments are fine grained. If the dredged material or ambient bottom consists of sandy or rocky sediments, it becomes more difficult to evaluate benthic community response using SPI because the soft-bottom successional model is not applicable. Thus, while SPI in most cases can be used to track and monitor the physical extent of dredged material disposal impacts, it is not universally applicable for monitoring the biological impacts of disposal. Where sediments are coarse or hard, alternate photographic techniques (e.g., sediment plan-view imaging using still or video cameras) combined with traditional grab sampling are probably the best choices, although alternative camera designs (r-SPI, Paavo 2007) coupled with further ecological understanding of these habitats (e.g., Cranfield et al. 2004) hold great promise for the future.

Overall, the development of the infaunal successional model and the ability to view the different stages of this model using SPI technology have had a significant influence on the way in which the biological impacts of dredged material disposal are both monitored and managed, particularly in the United States. The model allows predictions to be made about the expected timing and sequence of benthic recolonization following disposal; SPI gives managers the ability to evaluate the accuracy of such predictions in a timely and cost-efficient manner. Having this predictive and confirmatory capability has in turn supported the development of advanced, multitiered, *prospective* monitoring designs, as advocated by Fredette et al. (1990) and implemented under the DAMOS programme (Germano et al. 1994). A prospective monitoring design means that specific desirable and undesirable conditions are clearly defined prior to sampling, with the resultant monitoring focused on detection of changes in specific conditions rather than identifying any or all detectable changes. SPI is therefore used routinely under DAMOS and numerous other programmes to verify the prediction that recolonization will occur within expected timeframes, and habitat conditions over dredged material mounds eventually will become similar to those at nearby reference areas.

Sediment quality and BHM surveys

Because sediments are the ultimate sink for watershed contaminants or excess nutrients and therefore can serve subsequently as a source of these stressors to the aquatic ecosystem, both the sediments and their associated benthos have been obvious targets for ecosystem quality assessment of pollution impacts in many studies, through chemical screening of the sediments (e.g., Corbett et al. 2009), comparing differences in benthic community structure (e.g., Borja et al. 2000), or combining both approaches with sediment toxicity testing in a sediment quality triad framework (e.g., Chapman 1996). More recently, time-lapse SPI has been combined with diffusive gradient thin (DGT) gels that are incorporated into the faceplate of the SPI prism to obtain simultaneous *in situ* measurements of sediment colour and porewater trace metal profiles alongside qualitative estimates of faunal activity (Teal et al. 2009). Any aquatic sediment will have measurable chemical constituents, so the key variable of concern (what essentially defines pollution) is whether these chemical constituents are having adverse effects on biological receptors. Because infaunal benthos are relatively stationary, they have been a logical point of focus for benthic habitat impact assessment monitoring studies for more than 50 years, starting with the pioneering benthic system classification studies of Reish (1955) and continuing to the present day. Making sense of the species lists and population abundance data generated from traditional benthic sampling is not the focus of this review, but presents its own unique set of challenges (Diaz et al. 2004). In a similar vein, indices also were developed from SPI data (Rhoads & Germano 1986, Nilsson & Rosenberg 1997) in an attempt to assess benthic habitat quality, although other approaches are now routinely adopted (e.g., Godbold & Solan 2009).

Sediment and habitat quality studies

SPI has been used on its own or in conjunction with traditional grab sampling in a number of sediment quality studies. Because the sediment profile camera can sample stations arranged in grids or transects in rapid succession, SPI technology is particularly useful for baseline mapping or contouring of seafloor physical and biological characteristics, delineating areas affected by hypoxia/anoxia, identifying organic enrichment gradients, and documenting benthic habitat types across relatively broad areas of interest. During the 1980s and early 1990s, the emergence of the National Estuary Program (NEP) of the U.S. Environmental Protection Agency (USEPA) and concomitant increases in the funding of 'status and trends' monitoring initiatives at various levels of government resulted in sponsorship of several SPI-based sediment quality surveys, principally in larger U.S. estuaries. Prominent examples include mapping of organic enrichment gradients in relation to wastewater discharges in Narragansett Bay, Rhode Island (Valente et al. 1992); sediment quality surveys in

Long Island Sound and Chesapeake Bay (Day et al. 1988, Diaz & Schaffner 1988); and seafloor characterization surveys in San Francisco Bay, California (Revelas et al. 1987b).

Working in the Elizabeth River (Virginia, USA), Diaz et al. (2003) were able to map sediment hydrocarbon contamination with SPI through the identification of what they termed “H spots”, a unique optical feature caused by the interaction of the acrylic plastic of the camera prism faceplate, the sediment stickiness, and the hydrocarbon affinity for adhering to the acrylic. The sediment hydrocarbons lubricated the faceplate and caused the sediment to ‘bead up’ in an anomalous textural pattern that was readily visible in the profile images. Analyzing box core samples from the same stations for macrobenthos, sediment chemistry and X-radiography, Diaz et al. (2003) were not able to detect any gradient in hydrocarbon concentration or occurrence of H spots over the spatial distance they sampled. However, they were able to discriminate between higher contaminant concentrations in the upriver versus the lower contamination in the downriver portion of the area surveyed. While they were confident that the camera could detect the presence of liquid hydrocarbon contamination in the sediments, they did not find any evidence to quantify the degree of sediment-sorbed contaminants using conventional white-light imaging. Nonetheless, they did emphasize somewhat prophetically that the camera could be used as a rapid screening reconnaissance tool after an oil spill where hydrocarbons were still in the liquid phase. Because the attention in most oil spills has traditionally focused on shoreline impacts, SPI has not been used to date for oil spill monitoring despite its suitability for benthic impact assessment (Germano 1995) and prototype SPI technology (Tracey et al. 2000). However, the April 2010 Deepwater Horizon spill in the Gulf of Mexico (Mascarelli 2010) may provide the opportunity for testing the effectiveness of SPI as a damage assessment tool for subtidal benthic impacts in oil spill monitoring programmes.

Rosenberg et al. (1999) used a combination of SPI and grabs to characterize sediment quality in Ås fjorden in Lake Vänern, a freshwater lake in southern Sweden, west of Stockholm; both the grab and SPI results showed the greatest faunal activity and best sediment quality was found in the central and southern parts of this lake. In a similarly species-poor environment off the Åland Islands in the northern Baltic Sea, where large areas are in a persistent anoxic state, Bonsdorff et al. (1996) took grabs at 25 of the 42 stations sampled with SPI to characterize the bottom, assess sediment quality, and examine the applicability of SPI in low-salinity, species-poor environments. While the benthic samples showed no major differences in faunal dominance, number of species, or total community biomass among four major groups of stations located in the inner archipelago, the open coastal zone, the archipelago, and the open sea, the total infaunal abundance was higher in the open coastal zone as compared with the other three areas. The profile images documented the degree of benthic eutrophication, especially at the stations located in the inner archipelago around fish farms. The authors concluded that the SPI data were useful in classifying the benthic habitats and providing additional valuable information that showed significant correlations between the biotic (zoobenthos) and abiotic (total organic carbon, oxygen saturation) parameters measured.

While the majority of SPI studies have been carried out in temperate eutrophic or mesotrophic areas, a handful of studies have been carried out in the oligotrophic Mediterranean (Grehan et al. 1992, Makra et al. 2001, Karakassis et al. 2002). However, these three studies were restricted to areas of localized impact or did not attempt to correlate the *in situ* sediment structures quantified in profile images with quantitative benthic assessments. Rosenberg et al. (2003a) investigated whether SPI could be an effective or adequate monitoring approach in an oligotrophic system with poor benthic-pelagic coupling like the Mediterranean and specifically sampled an area in the Gulf of Lions (north-western Mediterranean) that had no marked signs of eutrophication. Random sampling took place in five study areas with different levels of organic enrichment and environmental disturbance; a total of 36 stations were sampled among the five areas with both grabs and SPI. In addition to sieving sediments for standard taxonomic analyses, the authors collected samples for grain size, total organic carbon (TOC), and total organic nitrogen (TON). Most stations consisted of silt-clay with TOC and TON (per cent dry weight) ranging from 0.15 to 2.93% and 0.03 to

0.41% respectively; macrofaunal abundance ranged from 0 to 270 individuals 0.1 m^{-2} , with the polychaete *Sternaspis* sp. the most common species in all areas and the bivalve *Brachyodontes* sp. with the greatest abundance (220 individuals 0.1 m^{-2}) at any location. The multidimensional scaling (MDS) ordination plot of the SPI attributes showed only one of the five areas to be homogeneous and, like the results from the macrofaunal data, showed the stations in the Gulf of Fos (adjacent to the mouth of the Rhone river) to be the most heterogeneous. The authors also used MDS on standardized SPI parameters (aRPD and camera penetration depth; presence of tubes, pits, mounds and burrows; number and depth of feeding voids) and compared the ordination results with those based on (1) macrofauna composition and (2) values of the Benthic Habitat Quality (BHQ) index (Nilsson & Rosenberg 1997). Both the faunal and SPI data gave complementary results, while the MDS based on the BHQ index did not separate two of the stations in one area surveyed off Banyuls-sur-Mer from all the other stations in that group (as was the case for the ordination plots from the faunal data and standardized SPI parameters). The authors concluded that results obtained from the BHQ suffered a minimal loss of information, and as in other past studies (Bonsdorff et al. 1996, Valente et al. 1999, Nilsson & Rosenberg 2000, Karakassis et al. 2002, Rosenberg et al. 2002), that the information obtained from SPI and faunal analyses are similar for assessing sediment habitat quality. One unexpected result from this study was the discovery of seafloor impacts from bottom trawling in the Gulf of Lions, which led to additional SPI investigations by Nilsson & Rosenberg (2003) and Rosenberg et al. (2003b).

Bona et al. (2000) used SPI as part of a multidisciplinary approach to assess sediment quality in the Venice Lagoon after an area in Lago dei Teneri was capped with clean sand to promote benthic recolonization. A total of 20 stations were sampled during each of 10 surveys between 1994 and 1997 (one before capping, one during, and eight after capping operations were completed). SPI was used along with sediment coring to obtain samples for chemical analyses and sediment bioassays using 10-day amphipod (*Leptocheirus* sp.) survival tests and the Microtox solid-phase test in a modified sediment quality triad approach (with SPI substituting for the benthic community analyses in the triad). The profile images provided documentation of benthic recolonization following capping, and sediment metal concentrations dropped substantially at stations in the capped area compared with those in the uncapped area. Over the course of the 3-year monitoring study, both reductions in the percentage toxicity in the capped area and improvements to the Organism Sediment Index (OSI) values (Rhoads & Germano 1986) measured from the profile images taken at capped area stations were dramatic, with the authors concluding that this type of integrated approach allowed them to quantify the environmental benefits following remediation activities.

Bona (2006) also used SPI to assess the impact of macroalgal blooms on benthic habitat quality based on data collected during an 8-year monitoring programme in the Venice Lagoon. Stations were divided into three groups (low, medium, and high macroalgal cover); the results showed that deposit-feeding stage 3 infauna disappeared when seaweeds became more abundant. A multiple-regression model was used to determine which environmental variables (water temperature, depth, macroalgal biomass and per cent cover) affected benthic habitat quality as represented by OSI values determined from profile image measurements, but the model explained a relatively low proportion of the OSI variance.

Diaz et al. (2003) compared both the OSI and the Benthic Index of Biotic Integrity (BIBI) developed by Weisberg et al. (1997) for use in Chesapeake Bay as tools to assess benthic habitat quality. Data from benthic grabs and sediment profile images collected at 230 stations over a period of 2 years in the Virginia portion of the Chesapeake Bay were compared to see if similar results would be obtained for station rankings. The correlation between the two indices was low ($r = 0.17$) and pointed to a discrepancy in how these two methods measured some (undetermined) function of benthic habitat quality. While there was a positive concordance (as one index increased, so did the other), the two techniques did not consistently give the same result for the same station; the BIBI either tended to underestimate habitat quality or conversely the OSI tended to overestimate habitat

quality, with the largest divergence occurring when the BIBI indicated good habitat quality. While the BIBI emphasizes species identity and richness as important features of benthic habitat quality, the OSI is a more process-oriented index that reflects both biological and, in particular, physico-chemical processes that structure sediments. The authors pointed out that both the BIBI and OSI appeared to be most responsive to organic enrichment (Pearson & Rosenberg 1978) and long-term events such as severe hypoxia (Nilsson & Rosenberg 2000), but the BIBI was more sensitive to short-term stressors that reduce species diversity and total abundance (the OSI would not change as quickly because biogenic sediment structures can persist after the organisms are removed).

One of the greatest stressors to benthic habitat quality on a global scale is coastal eutrophication with its resulting hypoxia and the growing number of aquatic dead zones (Rosenberg 1985, 1990, Nixon 1990, Diaz & Rosenberg 1995, 2008, Diaz et al. 2009). SPI has been used effectively in a number of monitoring programmes, both to document the occurrence of hypoxia and map the areas affected (SAIC 1987, 1988, Figure 13) and to study the ecological effects of areas known to be affected by seasonal hypoxia (Diaz et al. 1992, Rosenberg et al. 2001). Depending on the area of seafloor affected as well as the severity and duration of hypoxia, there may or may not be associated effects on benthic community structure. A study carried out in 1988 (June–August) and 1989 (June–September) in the York River in Chesapeake Bay, a region where seasonal hypoxia and anoxia have been recorded since the 1930s, documented the effects of hypoxia on infaunal benthos, epifaunal crustaceans, and fish (Diaz et al. 1992). While the authors documented relatively mild hypoxia in the summer of 1988, it was much more pronounced in 1989, with hypoxic (dissolved oxygen levels in bottom water < 2 ppm) conditions lasting for 3 days in June, up to 9 days in July, and for 19 consecutive days in August. However, weekly benthic samples collected at three stations showed no change in community structure (Shannon-Wiener diversity, species richness, evenness) associated

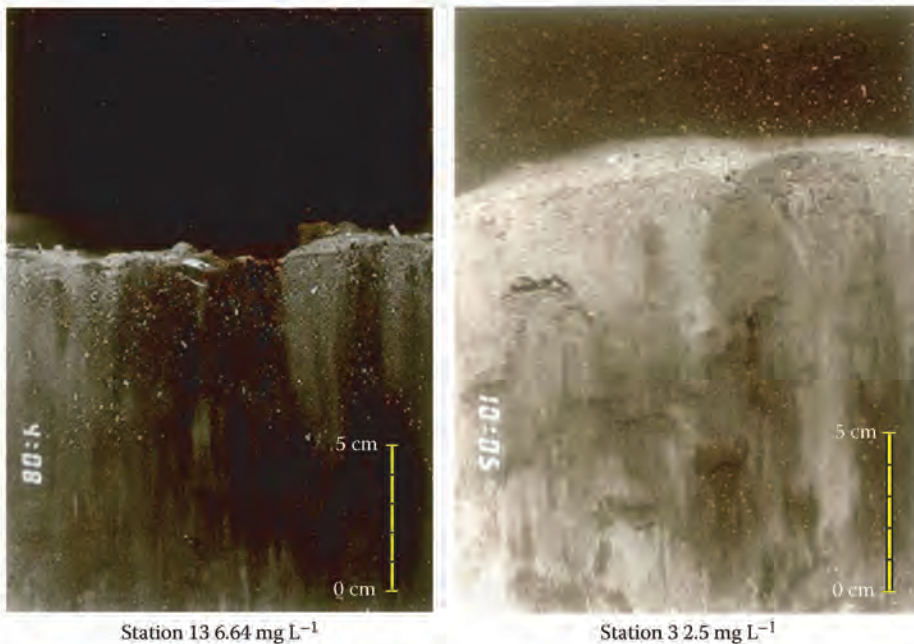

Figure 13 (See also Colour Figure 13 in the insert) These early black-and-white profile images from a 1988 monitoring survey in western Long Island Sound show the sediment profile image along with the associated dissolved oxygen concentration in the water column 1 m above the bottom. Even though the conclusion from water column monitoring would be that Station 13 is not located in an area affected by hypoxia or anoxia, the sediment profile reveals otherwise; conversely, the ‘problem’ identified at Station 3 is a transient water column phenomenon that is not of sufficient duration to affect the benthic ecosystem.

with the lower dissolved oxygen levels during the mild hypoxic events in 1988. Epibenthic crustaceans migrated out of the deep strata into shallow water in 1989 during the hypoxic periods, and the SPI photographs documented ophiuroids and sea cucumbers on the sediment surface with spionid polychaetes swimming in the water column, a common escape response for infauna that has been documented in other hypoxia studies (Stachowitsch 1984). The depth of the aRPD measured in the profile images also became progressively shallower through the summer of 1989.

In addition to documenting the presence of *Beggiatoa* sp. mats on the sediment surface (Rosenberg & Diaz 1993), profile images can provide forensic evidence of past anoxic events by documenting subsurface laminations or varved sediments that are created during seasonal hypoxic periods and not subsequently disrupted by bioturbation (Figure 14, Rumohr et al. 1996). Nilsson & Rosenberg (1997) used both plan view and SPI to document benthic impacts in an oxygen-stressed stratified fjord; grabs were taken at one-third of the stations to identify the fauna seen in the profile images. The authors documented laminae in some of the deeper areas (indicating no active burrowing infauna) and used the BHQ index to compare results from different areas sampled. Habitat degradation (as measured by the BHQ) from oxygen stress was shown to exist in areas deeper than 25 m as compared to stations in shallower strata. Using a combination of SPI and grab sampling, the authors later demonstrated in the Gullmarsfjord (Swedish western coast) a tight coupling between degradation of benthic habitat as measured by faunal behaviour, species richness, abundance and biomass once dissolved oxygen levels reached a critical concentration of 0.7 ml L^{-1} (Nilsson & Rosenberg 2000). Time series sampling with SPI showed that just before this critical threshold concentration was reached, the tube-building polychaetes extended their tubes higher into the water column, there was a decrease in the aRPD depth, and subsurface infaunal burrows that were formerly

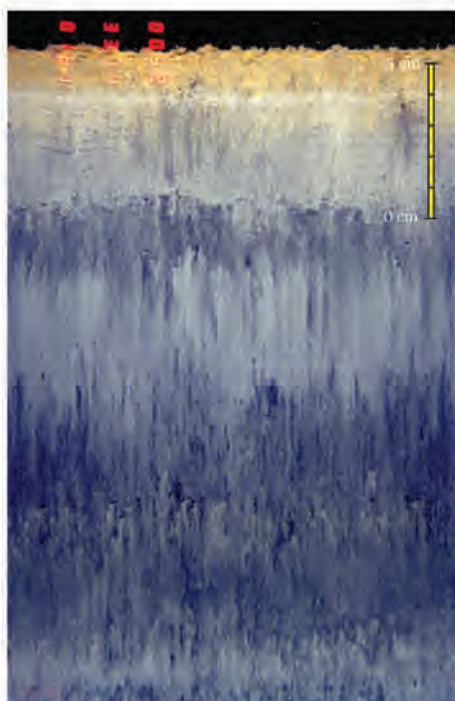

Figure 14 (See also Colour Figure 14 in the insert) This profile image from an anoxic basin in the Caspian Sea shows subsurface laminations that reflect annual depositional events; the sediment surface is oxidized during winter when the water column stratification breaks down only to be covered by a layer of anoxic detritus during the next period of water column stratification.

oxidized became black and sulphidic. During the extended period of hypoxia (10 months) in the Gullmarsfjord, the benthic successional stage declined from an equilibrium assemblage (stage 3) to virtually azoic conditions; once the hypoxic event ended, pioneering infauna (stage 1) recolonized the area. Continued studies in this region showed a restoration of the benthic community to pre-hypoxic conditions over a 2-year period, but the path of benthic community successional recovery did not retrace the path of degradation (Rosenberg et al. 2002).

Rosenberg & Nilsson (2005) continued to use SPI and grabs to assess long-term changes in the macrofauna due to large-scale eutrophication along the Swedish western coast and in three fjords, analyzing for TOC in the sediment as well as identifying the macrofauna and calculating the BHQ index from the SPI analysis. A series of stations sampled in 1976 were sampled again in 1987, 1990, and 1998 (SPI was used as an additional sampling tool only in the 1998 survey); the number of species and abundance showed a significant temporal decline in the fjord stations, with the TOC results indicating that the fjord stations were enriched compared to the coastal stations. The BHQ values from the fjord stations (overall mean of 4.4) were similar over the whole area but indicative of disturbed benthic habitats (stage 1 or low stage 2 in the model shown in Figure 5). Rosenberg et al. (2009) have continued to promote the use of SPI and the BHQ as a rapid means of assessing benthic habitat quality for the European Union Water Framework Directive (EU WFD), proposing an increase in the division of the BHQ (from the four successional stages as shown in Figure 5 to five stages that would correspond to alternative levels of ecological status proposed in the EU WFD: “high”, “good”, “moderate”, “poor”, and “bad”); they also acknowledged that the applicability of this technique may be useful only in true marine sublittoral soft bottoms in temperate and boreal areas. While both the BHQ and OSI can be useful ordination tools for SPI data, there is a variety of potential problems with using either index as a regulatory guideline tool (see ‘Discussion’).

An attempt to use the BHQ for water quality assessment was made by Shumchenia & King (2010) in Greenwich Bay, Rhode Island (USA); given the success reported in using SPI as a tool to monitor the effects of hypoxia (Nilsson & Rosenberg 1997, 2000, Rosenberg et al. 2001, 2002, 2009, Cicchetti et al. 2006), the authors in this study used SPI in a shallow (<10 m) embayment over a period of 2 years and tested for associations between the BHQ, SPI features and water quality over different time intervals and at multiple dissolved oxygen thresholds to determine empirical relationships between hypoxia prevalence, BHQ scores, and presence/absence of biogenic features visible in SPI. They found that the BHQ along with the presence of faecal pellets, tubes, feeding pits, voids, and mounds (all individual components of a BHQ score) had poor discriminatory power for water quality status that precluded their usefulness as indicators of hypoxia. However, burrow structures and the depth of aRPD were the most sensitive and specific indicators; the authors pointed out how the delayed response of biogenic features on the resumption of normoxic conditions could be due to other related stressors (organic enrichment) and emphasized the need to interpret the images in the context of the ecosystem under investigation instead of blindly relying on a calculated index, sentiments also emphasized elsewhere (Teal et al. 2010).

Benthic habitat mapping projects

Over the past 5 to 10 years, the Coastal Services Centre (CSC) of the National Oceanic and Atmospheric Administration (NOAA) in Charleston, South Carolina, has been involved in a series of comprehensive BHM projects in major rivers and estuaries throughout the United States. These have included the Hudson River and lower New York Harbour in New York, the Wells River in Maine, the York River in Virginia, and Apalachicola Bay in Florida (Table 2). Under its Landscape Characterization and Restoration (LCR) Program, NOAA typically establishes partnerships with regional stakeholders (e.g., USACE district offices, state-level natural resource agencies, National Estuarine Research Reserves, etc.) to identify resource management goals, determine mapping needs, collect data, and make the benthic mapping data products widely available through electronic media such as CD-ROMs and Internet Web sites.

Table 2 Recent benthic habitat-mapping projects in the United States involving extensive use of SPI and for which NOAA CSC has been a primary or secondary partner agency

Location	Partners	Techniques	References
Webhannet River and York River, Maine	Wells National Estuarine Research Reserve	Benthic grab and SPI data collected concurrently to map benthic habitats in both rivers	http://www.csc.noaa.gov/benthic/data/northeast/wells.htm (accessed 5 October 2010)
Lower New York Harbor	USACE–New York District	Benthic grab and SPI data taken concurrently to document benthic habitat and invertebrate community distribution	http://www.csc.noaa.gov/benthic/data/northeast/nynj.htm (accessed 17 February 2011) Iocco et al. (2000b)
Hudson River Estuary, New York	New York Department of Environmental Conservation, Columbia University, SUNY Stony Brook, and NOAA CSC	Sidescan sonar, multibeam bathymetry, subbottom profiling, SPI, grab sampling and coring to characterize benthic habitats	http://www.dec.ny.gov/imsmaps/benthic/viewer.htm (accessed 5 October 2010)
York River, Chesapeake Bay, Virginia	Virginia Institute of Marine Sciences and the Chesapeake Bay National Estuarine Research Reserve (NERR)	Sidescan sonar, swath bathymetry, sediment grabs, and SPI to document the distribution and occurrence of benthic habitats, bottom types, and invertebrate communities	http://www.csc.noaa.gov/benthic/data/northeast/york.htm (accessed 5 October 2010)
Apalachicola Bay, Florida	Apalachicola National Estuarine Research Reserve	Benthic grabs, SPI, and RoxAnn™ acoustics data taken concurrently to document the distribution and occurrence of benthic habitats, bottom types, and invertebrate communities	http://www.csc.noaa.gov/benthic/data/gulf/apa.htm (accessed 5 October 2010) Iocco et al. (2000a)

SPI has been utilized on several of these projects, typically in conjunction with one or more additional seafloor mapping techniques (Table 2). These have included various acoustic methods for mapping bottom topography and seabed physical characteristics over broad spatial scales, such as single/multibeam bathymetry, side-scan sonar, and the RoxAnn™ ground discriminating system. Concurrent SPI and benthic grab sampling typically have been conducted using dense station grids, allowing for additional mapping of sediment physical and biological characteristics and benthic community metrics. The SPI and grab-sampling data also have been used to ground truth the broad-scale acoustic methods.

SPI has also been employed in emerging state-sponsored BHM projects. The Massachusetts Office of Coastal Zone Management (CZM) and United States Geological Survey (USGS) Woods Hole Science Centre initiated a Seafloor Mapping Cooperative to address the need for acquiring datasets on the spatial distribution of benthic resources to help resource management. The goal of the cooperative is to map the bathymetry and surface geology of the seafloor comprehensively in Massachusetts. Seafloor mapping efforts that combine high-resolution acoustic bathymetric and backscatter images with optical imaging techniques (SPI, plan-view cameras and video) are revealing the complexity of the seafloor landscape as a mosaic of interconnected seafloor habitats (Valente et al. 2007). Similar initiatives incorporating the use of SPI have commenced in UK waters, primarily in the North Sea, through various projects carried out by CEFAS (Centre for Environment, Fisheries and Aquaculture Science) in Lowestoft, and the use of SPI has recently been extended to several routine large benthic status surveys.

The advantage of using SPI as a BHM tool to derive process-oriented information about benthic ecosystem dynamics was illustrated in a 2001 survey in Daya Bay, located on the south-eastern

coast of the People's Republic of China. The SPI survey was undertaken prior to construction of a large petrochemical facility on the northern shore of the bay between Aotou and Xiayong (Germano & Associates 2001). A baseline study performed 4 years earlier was deemed insufficient, given its attempt to characterize the 600 km² bay with only 15 grab-sampling stations. The SPI survey was carried out over 4 days at 190 stations spread throughout the bay. The objectives were to determine the characteristics of the benthic habitat and infaunal communities in the area and to characterize gradients in sediment type and organic loading. The results showed that the bay was mostly fine-grained sediments and largely depositional except for a few isolated areas of fine sand or cobble bottom. One of the most distinguishing characteristics of the images from this survey was the organic inventory inferred from the sediment profiles. Stations appeared to be at one of two extremes, either depauperate of carbon or carbon enriched. The presence of an organically enriched layer at the sediment surface was widespread throughout the bay (Figure 15) and appeared to be derived from two different sources: biodeposition from mariculture sites and recent land run-off from a typhoon that had passed through the area 3 weeks prior to the survey. Regardless of source, the layer ranged in thickness from a few centimetres to greater than the prism penetration depth. Stations with an enriched organic surface layer presumed to be the result of the typhoon were easily distinguished by the light grey colouring to the organic layer (Figure 16A), while those experiencing organic enrichment from the mariculture activities showed highly reduced surface sediments with an apparent high sediment oxygen demand (Figure 16B).

The most striking result from this survey, in terms of sediment quality and ecological impacts, was the apparent imbalance in the sediment organic carbon budget throughout Daya Bay. Overall, the benthic community in Daya Bay was not impaired; even though the average aRPD depths were somewhat shallow (more a function of the organic carbon imbalance), mature stage 3 assemblages were prevalent throughout the surveyed area. While the pulse of organic-rich sediments introduced to the system by the typhoon run-off showed the beneficial effects of enhanced secondary production (Rhoads et al. 1978), there were also areas at risk surrounding the mariculture activities that were rapidly becoming eutrophic and experiencing nutrient overenrichment. The impacts of the excess food pellets and biodeposition from both faeces and pseudofaeces were detected as far as 2–3 km away from the mariculture rafts. The overall conclusion from the survey was that mariculture activities were having the biggest impact on the bay. Predictions were made that if mariculture activities were left unchecked without better environmental management (such as in Scotland; Mayor et al. 2010), it could lead to areas of the bay becoming eutrophic with either algal blooms or periodic hypoxia or anoxia. A few months following completion of the survey, Daya Bay experienced massive algal blooms and a fish die-off in the farmed pens in the nearshore areas identified in the SPI survey as organically enriched (Wang et al. 2004).

Sewage and waste monitoring

The results from an SPI survey designed to assess impacts of untreated sewage effluent off the city of Athens, Greece, displayed the classic response to organic enrichment corresponding to the Pearson & Rosenberg (1978) phenomenological model (Makra et al. 2001). Stations closest to the outfall had no measurable aRPD and significant inventories of opportunistic infauna (stage 1 assemblage) and showed subsurface methane voids indicative of excess organic enrichment. With increasing distance from the outfall, the benthic community transitioned to a predominance of deposit-feeding infauna, but no stage 3 community (Figure 5) was encountered at the end of the sampling transects. The gradient in organic loading and benthic community assemblage, as detected by SPI, was in agreement with the three zones of decreasing pollution impact documented by a previous benthic study (Simboura et al. 1995).

Long-term trends in benthic habitats were also mapped with SPI and traditional grab sampling over a 14-year period in Boston Harbour to assess the impacts with relocated sewage outfalls and

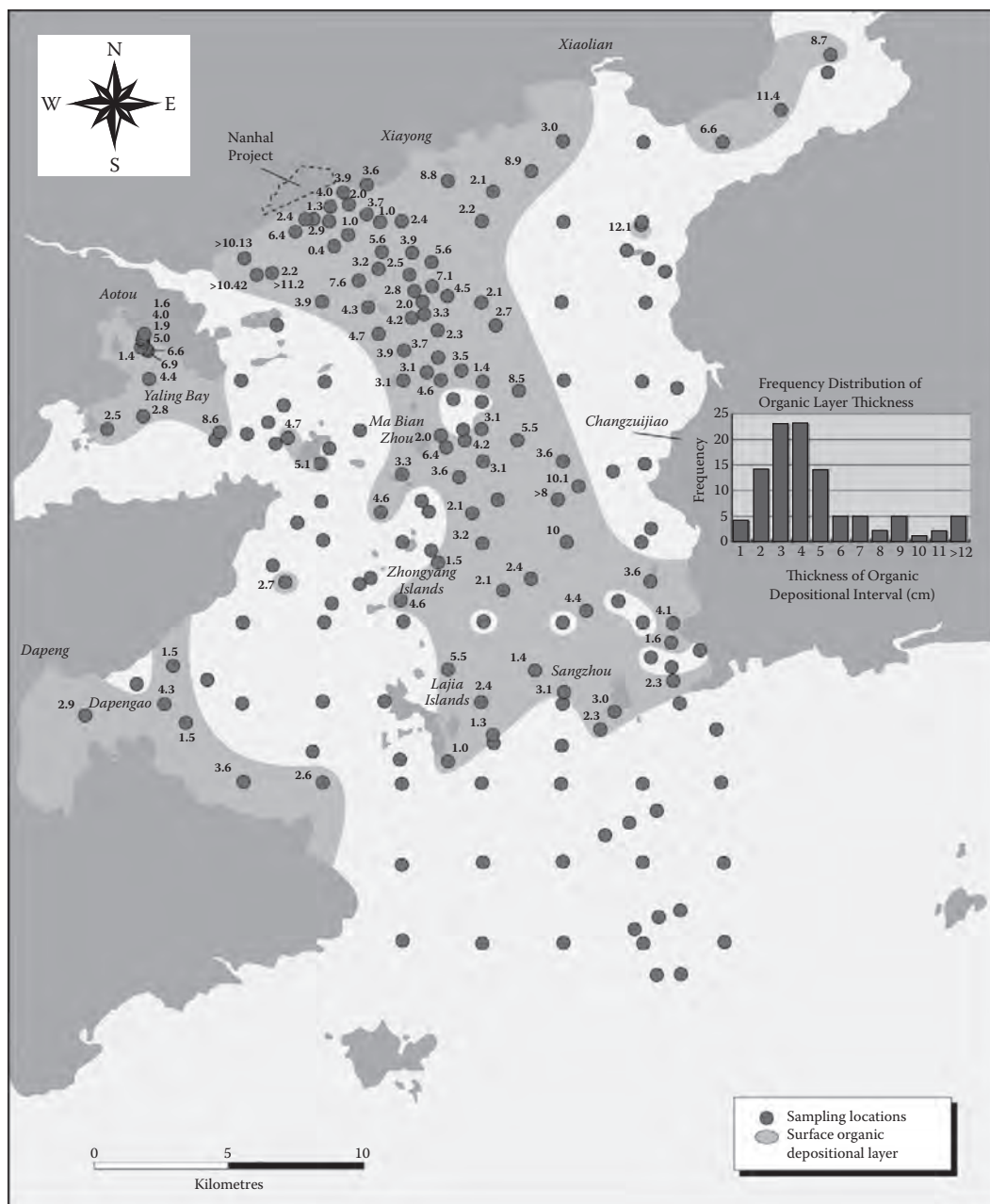

Figure 15 Distribution and thickness (centimetres) of organically enriched surface sediment layer in Daya Bay, China.

improvements in wastewater treatment (Diaz et al. 2008). Between 1992 and 2000, wastewater discharge switched from within-harbour outfalls to an offshore ocean outfall, with a reduction in organic carbon loading to the harbour from 11,400 to 1200 tonnes year⁻¹. From 1992 to 2006, a series of soft-sediment stations (low energy, depositional areas) throughout the harbour were sampled with SPI and grabs. The thickness of the aRPD was related to time, region within the harbour, and the presence of *Ampelisca* spp. tube mats; the authors found that the presence of dense

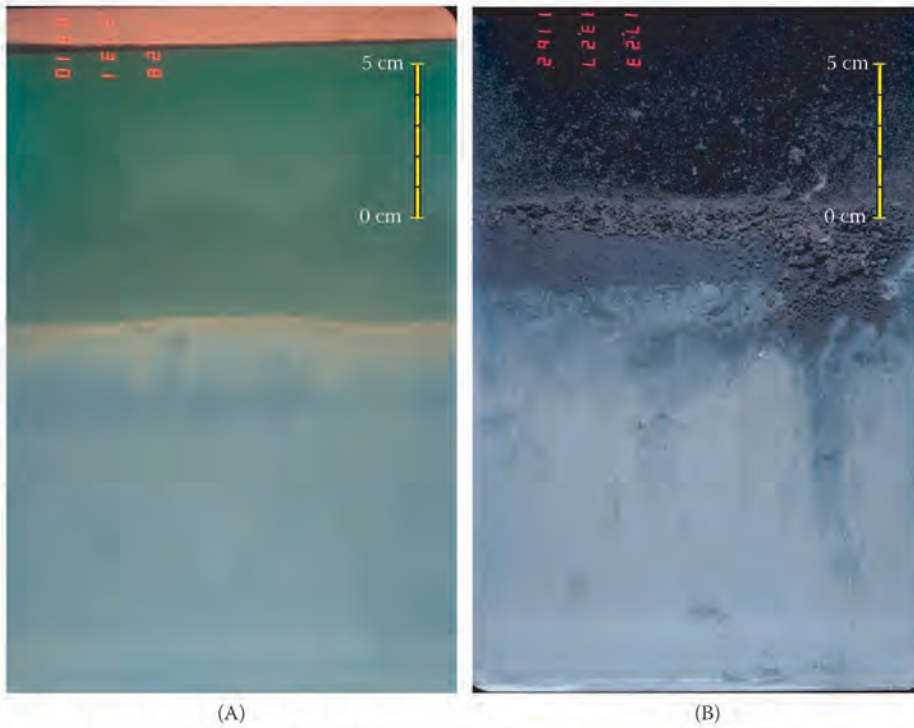

Figure 16 (See also Colour Figure 16 in the insert) Sediment profile images showing the differences in grey-scale contrast in the organically enriched layer in Daya Bay, China, as a function of source. (A) Sediment profile image showing a light grey layer of organic input from the recent storm run-off. (B) Sediment profile image showing highly reduced, anoxic organic material at the sediment-water interface from nearby oyster mariculture rafts.

colonies of this tube-building amphipod had the most influence in deepening the aRPD. Densities of tube mats increased each year until 1997, when the colonies were found at 60% of the stations. Starting in 1998, amphipod presence started to decline until 2004, when only 13% of the stations showed evidence of *Ampelisca* colonies. During the monitoring survey in the next year, there were no tube mats observed in any of the profile images collected; the harbour-wide decline in amphipod tube mats was consistent with reduced carbon and nutrient loadings from 1992 to 2000 when the ocean outfall started operating. One unexpected result of the amphipod colony disappearance was an overall decline in benthic species richness and diversity, most likely due to the reduction in habitat complexity in the absence of amphipod tubes. Based on the patterns of association among SPI variables, sediment parameters, and infaunal data, the authors were able to rank stations from lower to higher habitat quality; at higher levels of organic carbon enrichment, the benthic habitat was dominated by anaerobic processes, whereas at lower organic carbon levels, the benthic habitat was more aerobic with evidence of greater bioturbation activity. The monitoring results showed that the improvements in wastewater treatment along with moving the outfall off shore improved the within-harbour benthic habitats by favouring processes that enhance bioturbation rates.

One of the more unusual waste-monitoring surveys performed with SPI technology involved mapping the extent and impact of fish waste piles on the seafloor in Tongass Narrows, off the coast of Ketchikan, Alaska, where several major seafood-processing plants are located along the waterfront of the city (Germano & Associates 2004). Seafood processors in this area discharge the unused portions from their processing facilities to the seafloor via pipelines, and the discharged solids result in a pile termed a ‘zone of deposit’ (ZOD) that varies in size from less than a hectare

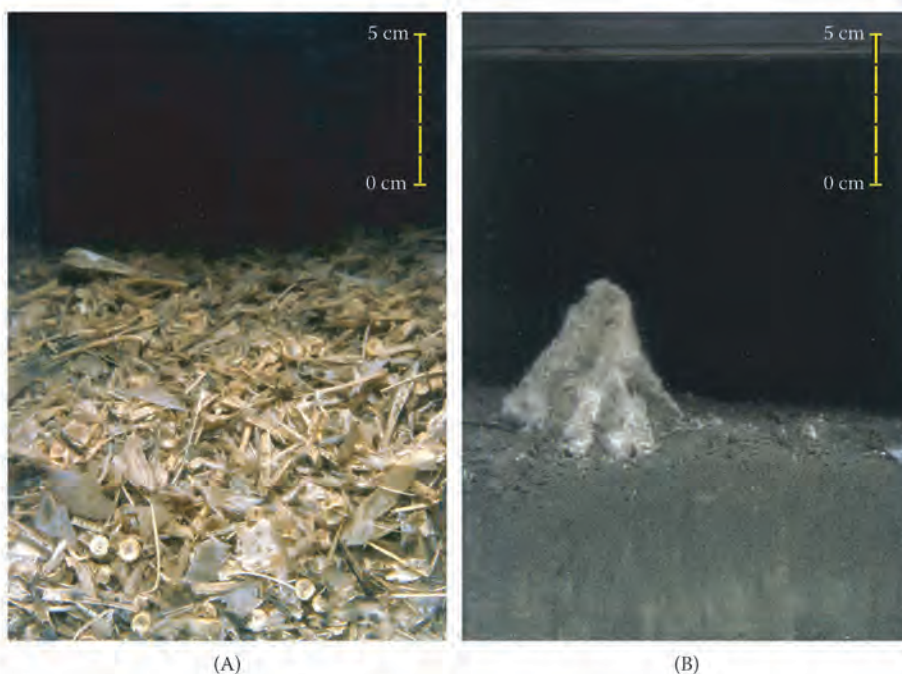

Figure 17 (See also Colour Figure 17 in the insert) (A) The obvious effects of fish waste discharge can be seen in the collection of skeletal remains in this profile image from Tongass Narrows, Alaska. (B) Sediment profile image showing a chunk of fish waste on the sediment surface covered by *Beggiatoa*; note the lack of any surface-oxidized layer in the sediment, also indicative of low dissolved oxygen in the overlying water.

to several hectares in each area. Annually, a pile may receive wastes ranging in total weight from approximately 50 tonnes to thousands of tonnes, with resulting piles of varying thickness. SPI was used to delineate the extent of four different waste piles and assess their impacts on the benthic infaunal community; grab samples were also taken at a subset of sampling locations to ground truth the SPI interpretation as well as provide samples for TOC measurements.

The presence of fish waste on the bottom was readily apparent in the profile images from all four areas surveyed (Figure 17A), and the footprint of the detectable deposit varied in size at each facility. A more realistic assessment of the area of seafloor actually affected by the waste discharge was determined from looking at the extent of the *Beggiatoa* sp. colonies that had formed on the seafloor around these waste piles. These colonies of *Beggiatoa* sp. (indicative of low-oxygen conditions; Rosenberg & Diaz 1993) were good indicators of areas experiencing stress from organic loading (Figure 17B). The survey results showed a 3-ha area of seafloor experiencing adverse effects from excess organic loading around the two active seafood-processing facilities, and the benthic infaunal community was responding to the fish waste discharge in a way that was completely consistent with the well-established model of community response to organic enrichment (Figure 5, Pearson & Rosenberg 1978). Specifically, both the sediment profile images and the taxonomic composition results from the grab samples showed the classic pattern of high densities of opportunistic species nearest to the source of the organic loading.

Logging operations in the Pacific North-west of the United States (Washington and Alaska) over the past 100 years have resulted in wood waste accumulation at the bottom of many marine coastal areas and freshwater lakes from log storage, rafting, and transfer operations by various pulp and paper companies. In June 2003, the Alaska Department of Environmental Conservation (DEC) conducted a preliminary survey of bark and wood waste in Thorne Bay (approximately 72 km north-west of Ketchikan, Alaska), a former log storage and transfer facility for the Ketchikan Pulp Company,

using a remote video camera and diver observations. Based on the data collected, DEC estimated that approximately 0.08 km² of bottom sediments in northern Thorne Bay were covered completely by a layer of aging bark and wood waste of varying thickness (Germano & Browning 2006).

As required by the United States Clean Water Act, the USEPA and the DEC began preparing a total maximum daily load (TMDL) for the defined pollutant parameter of 'residues' for Thorne Bay. In the summer of 2005, a multidisciplinary monitoring survey involving water and sediment sampling, benthic grab sampling, sediment profile and plan-view imaging, and diver surveys was performed to better characterize the extent and nature of wood residues present in Thorne Bay (Germano & Browning 2006). The objectives were to determine if water quality standards were being exceeded in the water column above areas of differing wood residue coverage and to characterize the nature and extent of any benthic community impairment. A total of 109 stations were sampled with sediment profile and plan-view imaging in the previously identified 0.08 km² along with four reference stations. Diver observations, sediment grabs, and water column profiles/samples were taken at a subset of 12 stations in the area of impact and the four reference stations.

The SPI results showed that surface sediments in the Thorne Bay survey area were primarily silts and clays, with varying proportions of fine-to-medium sand mixed within the silt/clay matrix. In addition to typical lithic and clastic sediment particles, allochthonous particles such as wood, bark, and leaves along with authigenic biological particles, such as bivalve shells, were present within the sediment at many stations. Wood residue was present in a variety of forms, including bark fragments, wood chips and fragments, wood fibres, sticks and limbs, logs, deciduous leaves, and conifer needles. Some stations showed wood residue distributed throughout the sediment column, while at other stations it was present only in the upper portion of the sediment column or at the sediment-water interface (Figure 18).

The water quality parameter of primary concern to DEC in Thorne Bay was dissolved oxygen because this can be reduced through the decomposition of accumulated organic matter such as wood residue. Dissolved oxygen concentrations at all stations and depths sampled in Thorne Bay were well above the state water quality standard of 5 mg L⁻¹. Most measurements

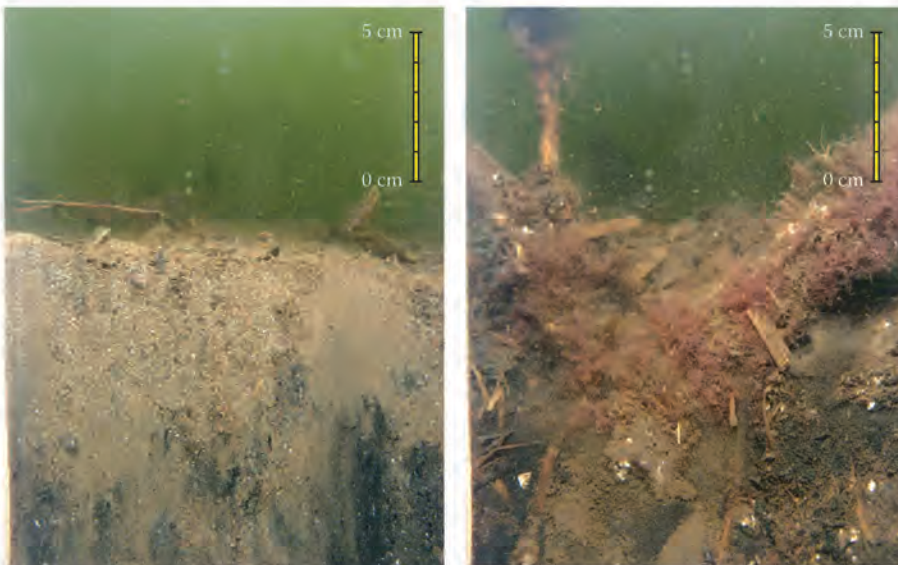

Figure 18 (See also Colour Figure 18 in the insert) Sediment profile images from Thorne Bay, Alaska, showing wood debris in varying sizes and at various depths throughout the sediment column.

indicated dissolved oxygen concentrations of 10–12 mg L⁻¹, with several readings greater than 12 mg L⁻¹.

A total of 4086 individuals were counted and identified from the 16 stations where grab samples were collected in Thorne Bay. The polychaete *Nephtys cornuta* was numerically dominant, occurring at every station and comprising 12% of the total abundance (Germano & Browning 2006). Except for this stage 3 polychaete, no other taxon accounted for more than 4% of the total abundance. Total faunal densities (m⁻²) at all stations ranged from approximately 1200 to 4200 individuals.

Exploratory statistical analyses were performed to investigate the relationships among measured sediment parameters, bark coverage designations (both in plan-view and cross-sectional images), and benthic infaunal successional status. Because the benthic community throughout the site was extremely healthy and no gradients of stress impacts were detected (regardless of the amount of wood residues present), there were no apparent relationships between any of the wood waste measurements (on either the sediment surface or in the cross-sectional images) that could be related to benthic community status in either the grab samples or the sediment profile images.

The results of this study were particularly dramatic in light of historical surveys that had been performed at the site by divers alone. DEC had assumed that the presence of wood residues was equivalent to benthic impairment, and diver surveys merely documented (through visual estimates) the per cent cover of wood on the seafloor along surveyed transects. The SPI results (confirmed by the grab samples) and the water column measurements showed that neither the water column nor the benthic community was adversely affected by differences in the magnitude of wood residues; SPI technology was able to sample a much larger area more accurately and cost-effectively than either divers or traditional grab sampling. Based on these results, DEC removed the former log storage area in Thorne Bay from the state's impaired water body list.

Sand mining impacts

While the effects of aggregate and sand mining on the seafloor have been studied extensively in various areas of the world (see review by Newell et al. 1998), SPI has been used with varying levels of success in sand mining studies in Hong Kong and off the eastern coast of the United States.

Hong Kong sand mining

Until the early 1990s, land reclamation in Hong Kong was accomplished by excavating hillsides, but marine sand mining was initiated to accommodate large construction projects such as the Chep Lap Kok airport (requiring 306 million m³ of fill) and the new Disneyland Park in Pennys Bay (61 million m³ of fill). The offshore sand resources are largely alluvial deposits laid down in the complex, systematic network of river channels that were submerged during the Holocene sea-level rise (Fyfe et al. 2000); as the sea level rose, a swath of marine mud was deposited on top of these alluvial deposits. The sand mining activities have been concentrated in those areas where the layer of surface mud is relatively thin, ranging in thickness from about 2 to 6 m.

Between 1993 and 2001, SPI was employed as one of the key monitoring tools in a series of studies on the impacts of dredging, borrow pit filling, open water disposal, and sand mining (Rhoads et al. 1995, Valente et al. 1998a). Because a thick layer of Holocene mud covered the sand resources in this region and also quickly backfilled areas from which sand had been mined, the seafloor was amenable to the use of SPI. One of the most successful applications of the profile camera was in documenting the actual footprint of a hopper dredge overflow plume that had settled on the bottom in the East Lamma Channel Marine Borrow Area (ELCMBA), one of the main sand resources for infilling of Pennys Bay for the construction of Hong Kong Disneyland.

The major environmental concern associated with dredging operations at the ELCMBA was the suspension of fine sediments into the water column and their direct impacts on water quality. These effects, as well as potential impacts through deposition of fine sediment dispersed by the overflow

plume on nearby bathing beaches, seawater intakes, capture and culture fisheries resources, corals, and turtle nesting grounds, were assessed in detail by hydraulic modelling studies. To assist in calibrating the hydrodynamic models and verifying the modelling results, sequential SPI surveys were performed in February and March of 2001. Stations were spaced 100–200 m apart and arranged in radial transects to delineate the footprint of the deposit surrounding the borrow area. A total of 238 locations were sampled over the course of three surveys to map both the spread of the deposit over time during disposal operations and to document impacts to the local benthic community.

Formerly suspended settled fine (FSSF) sediments were readily detected in the sediment profile images due to their uniform fabric (all fine-grained clay particles), high reflectance, and relatively low bearing strength. Because dredging operations were still ongoing during the course of all three surveys, some of the locations had newly deposited FSSF layers that had not yet consolidated and were rather fluid in nature. One initial concern was whether the SPI technology would be able to distinguish the FSSF from the native, ambient muds because of the expected similarity in grain size and hydrodynamic disturbance associated with SPI deployment. The results from the first survey quickly eliminated these concerns; the FSSF layers were easily distinguishable from native sediments (Figure 19A). The lateral extent of the FSSF layer surrounding the borrow area could be mapped with SPI technology, even extending to the thin edges of the deposit apron (Figure 19B).

The initial model runs had projected sediment deposition occurring along the main axis of the channel but primarily to the south-west of the borrow pits. SPI technology proved particularly effective in mapping the actual footprint of the deposit, which was quite different from the footprint projected by the hydrodynamic model. While modelling can be a useful and effective screening tool, it is important to verify any modelled predictions prior to making resource management decisions. This study demonstrated that SPI can be a particularly effective tool to verify sediment transport and deposition models.

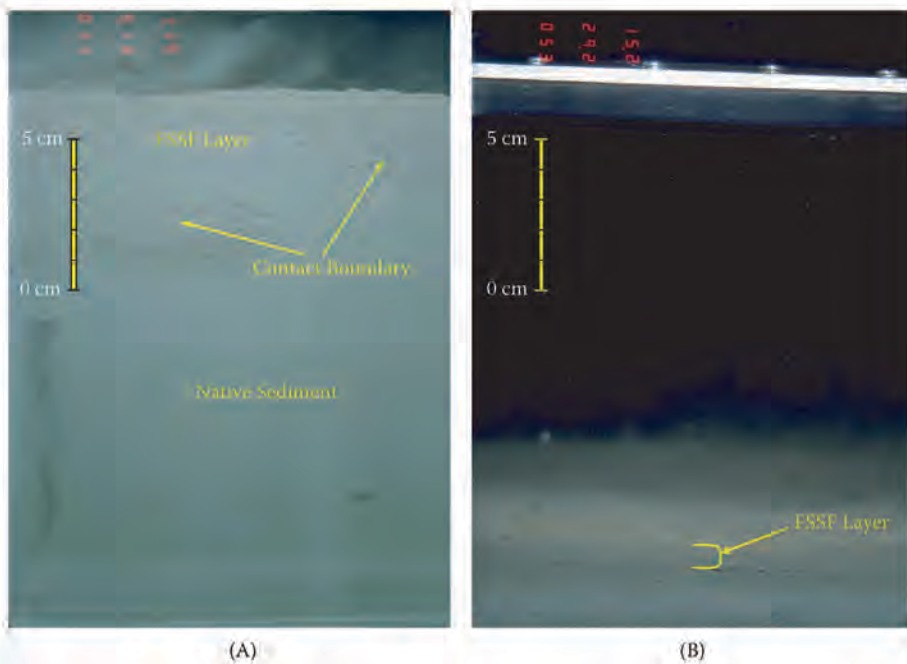

Figure 19 (See also Colour Figure 19 in the insert) East Lamma Channel Marine Borrow Area, Hong Kong. (A) Sediment profile image showing distinct contact boundary between formerly suspended settled fine (FSSF) layer and underlying native sediments. (B) Sediment profile image showing edge of deposit flank; FSSF layer is approximately 1 cm thick.

United States eastern coast sand mining

The Bureau of Ocean Energy Management, Regulation and Enforcement (BOEMRE) (formerly the U.S. Minerals Management Service) oversees outer continental shelf (OCS) areas that might be leased as sand borrow areas for beach nourishment, coastal restoration, or wetlands protection projects or areas in which existing coarse sand and gravel deposits might be exploited for use as construction aggregate. Since 1992, BOEMRE has conducted site-specific, interdisciplinary studies in identified sand borrow areas to provide basic information on the biological character of resident benthic communities, as well as the evaluation of potential dredging effects on the local wave and current regime.

The primary purpose of these studies has been to address potential adverse environmental impacts on marine life as a consequence of dredging sand on the OCS. To develop an understanding of the baseline benthic ecological conditions at offshore borrow sites prior to any dredging activity, the BOEMRE has funded studies that have included the compilation and synthesis of existing environmental information, as well as sampling surveys of the intended offshore borrow areas.

The biological field-sampling surveys have involved the collection of traditional benthic grab samples, sediment profile images, fish trawls, and video sled footage. As a result, the BOEMRE has been able to characterize benthic and pelagic communities inhabiting offshore borrow sites and to evaluate the potential rate and success of recolonization following cessation of dredging. SPI has been used with limited success in BOEMRE-funded studies off the coasts of New Jersey, Delaware, Maryland, North Carolina, and Virginia. Unlike in the waters surrounding Hong Kong, most of the sand resources in these areas of interest were not covered with mud but instead were exposed directly at the seafloor surface. Because these surface sediments were primarily fine-to-medium sands with little or no silt/clay content, penetration of the sediment profile camera was often limited. Furthermore, the lack of fine-grained material made measurement of the aRPD or assessment of the infaunal successional status difficult to impossible (Figure 20). As indicated, the successional dynamics of invertebrate communities in sand and coarser sediments are not well known, and the insights gained from SPI technology therefore are fairly limited in these environments.

In the BOEMRE studies conducted in the offshore waters of Maryland and Delaware, benthic grab samples showed that infauna were present within surface sand layers, but apparent biogenic features were not visible in the profile images. In both studies, resident macroinvertebrate communities were found to comprise organisms adapted to the energetic conditions that maintained the 'clean sand' appearance. Such organisms do not tend to build lasting structures, the basis for community structure interpretation of sediment profile images. Among the organisms present were very small ascidians (tunicates or sea squirts) and deep-burrowing amphipods. Because the ascidians were attached to the sand grains and about the same size, they were rarely visible in the profile images. Hence, the information on the benthic community structure gained from the profile camera in these studies was of limited use. Generally speaking, SPI is more successful and an appropriate tool for benthic infaunal community structure assessment where biological and physical sediment features can be preserved in finer, more cohesive sediments.

Energy exploration and production surveys

Over the past 10 years, SPI has been used in an increasing number of baseline characterizations for proposed marine liquid natural gas (LNG) pipeline routes and terminals and proposed wind farm terminal locations and cable routes and for mapping the extent and impact of oil drilling production platform discharges, such as produced waters, drilling muds, and cuttings. Rumohr & Schomann (1992) conducted one of the first SPI surveys around an exploratory drilling rig in the North Sea; while bad weather severely curtailed their intended sampling efforts, they were able to collect SPI

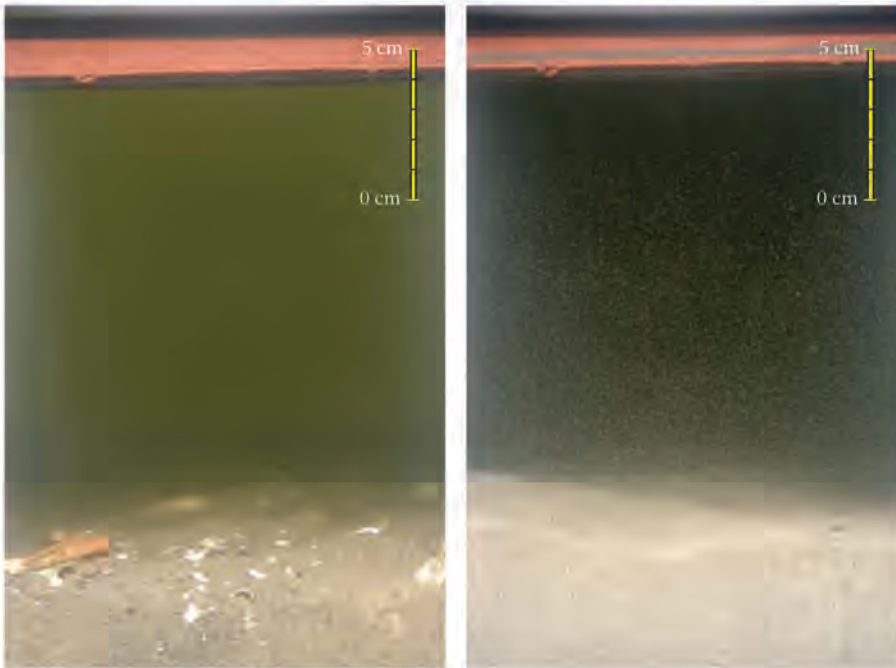

Figure 20 (See also Colour Figure 20 in the insert) These sediment profile images from BOEMRE-sponsored baseline studies for sand mining impacts off the eastern coast of the United States are typical; note how the limited penetration does not allow for much more than an assessment of sediment grain size or small-scale boundary relief measurements.

data at a limited number of stations and showed that the seafloor was heavily affected by storm and bottom current action. They were able to show from the profile images that oil-based drilling muds were not present in surface sediments around the rig because of the active sediment transport that had occurred during the recent storm.

With approaches similar to those employed at dredged material disposal sites, scientists and resource managers have recently started using SPI technology to delineate the footprint of discharged drilling muds and cuttings around the base of oil platforms and assessing impacts to the benthic community there. SPI has been used both in the Gulf of Mexico and the Caspian Sea for initial baseline studies prior to oil and gas tract leasing as well as during postdrilling studies to investigate the extent and nature of impacts around production platforms. One study for the U.S. BOEMRE in the Gulf of Mexico in the summer of 2001 was designed to assess the impacts of synthetic drilling muds on the seafloor (Germano & Associates 2002). The distinct optical signature of the drilling muds made them easily detectable in the profile images (Figure 21), so the extent of the seafloor affected by platform discharge was easily mapped.

The rapid increase in installation of subsea electrical cables, gas pipelines and offshore renewable energy facilities has led scientists and resource managers to use SPI technology in conjunction with acoustic mapping technologies to map suitable routes for cable and pipeline installation (CoastalVision 2010) as well as to evaluate pre- and postconstruction conditions on the seafloor (Germano & Associates 2010). The combination of SPI and plan-view underwater cameras has been particularly effective in documenting the physical disturbance and biological recovery of cable and pipeline installations (Germano & Associates 2010). Lessons learned from previous offshore cable and gas pipeline projects have led to improved route planning to avoid critical habitats and hard bottom areas unsuited for jet plough installation technologies (CoastalVision 2010).

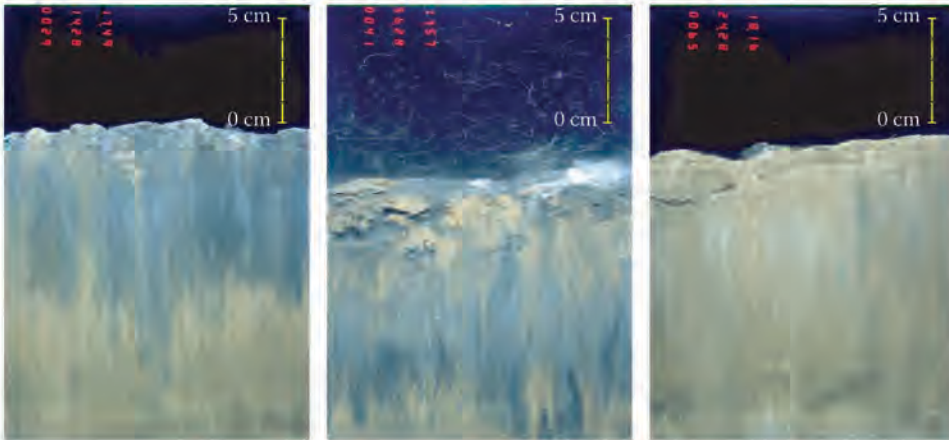

Figure 21 (See also Colour Figure 21 in the insert) These sediment profile images from a transect survey in the Gulf of Mexico approaching an oil platform show the presence of synthetic drilling muds as a dark layer on the sediment surface. The white, string-like filaments are colonies of *Beggiatoa* bacteria.

Aquaculture impact assessment

The first application of SPI technology for studying the impact of intensive aquaculture on the estuarine seafloor was in the early 1980s. The north-western coast of Spain (Galicia) in the region of the Rias Bajas experiences seasonal deep-water upwelling across the narrow shelf. This nutrient-rich water is driven into embayments (rias) facing the Atlantic Ocean. The upwelled water supports an extensive raft culture of mussels in the embayments, the Ria de Arosa and Ria de Muros y Noya. In the early 1980s, the Ria de Arosa contained over 2000 rafts supporting suspended rope deployments of *Mytilus edulis*. It was estimated that this aquaculture produced the highest known protein yield per unit area, with over 100,000 tonnes of mussels produced in an area of 230 km² (Tenore et al. 1982). At the same time, the Ria de Muros y Noya, located immediately north of the Ria de Arosa, had a few rafts (approximately 100) but showed minimal impacts from these mussel deployments and therefore served as a comparative reference.

The Spanish-American Rias Study (SARS) was established to understand the impact of this extraordinary secondary production on both water and sediment quality on the Ria de Arosa. Areas of study included gradients in organic loading by mussel faeces and associated changes in sediment geochemistry, porewater flux rates, sediment respiration rates, and benthic biology. The field investigation was therefore complex, with a spatially diverse measurement programme conducted during the upwelling period. A rapid method was needed to make real-time decisions in the field for locating measurement sites. This was the first time that SPI was used as a reconnaissance method to develop an efficient sampling plan in real time.

The SPI camera used in the SARS was the prototype video profile camera (Rhoads & Germano 1982). The prototype video SPI camera was deployed along gradients extending away from raft clusters to open water. It provided valuable real-time information about benthic enrichment gradients from information on bioturbation depth, sediment type, and the distribution and relative density of key benthic macrofauna. With this information, the investigators were able to select stations in real time for grab and core sampling and deployment of benthic chemical flux chambers.

Although the prototype video system suffered from poor optical resolution, was limited to black-and-white imaging, and had no option for recording images, the utility of being able to see the bottom in profile in real time was a major breakthrough in 'quick-look' sediment-quality mapping. It was clear that an improved digital colour still camera or video system would be a useful and cost-effective management tool for monitoring the impacts of intensive mariculture on sediment

quality. Information from such a system could be used for selecting new raft sites, removing rafts that are degrading the bottom, or rotating raft clusters to minimize long-term negative impacts to sediment and water quality caused by mussel aquaculture. This experience also suggested that real-time video might be useful in a time-lapse deployment to see active benthic processes such as deposition or erosion events, day-versus-night benthic activity, and modality and rates and depths of particle bioturbation; later studies by Diaz & Cutter (2001) and Solan & Kennedy (2002) proved this to be true.

Salmon cage and mussel raft culture are significant industries along the western coast of Ireland. High densities of caged salmon are fed with commercially produced food pellets; excess feed settles to the bottom along with salmon faeces, potentially causing problems with organic loading and associated high oxygen demand. Mass mortalities of salmon can take place within embayments affected by eutrophication, resulting in substantial financial losses. In 1987, the Commission of the European Communities (CEC) expressed interest in evaluating the effectiveness, efficiency, and advantages of SPI technology for monitoring the ecological status of the Lettercallow, a shallow embayment in Ireland containing several salmon pens and mussel rafts. Traditional benthic sampling prior to salmon culture was used to characterize the ambient sediment and benthic community conditions in the absence of mariculture.

Fifty-seven stations were sampled with SPI technology near and away from mariculture operations (O'Connor et al. 1989). Three SPI replicates were taken at each station (171 images total) in a 2-day period, with complete analysis accomplished within 2 weeks. Imaged features of the sediment column were measured from film negatives and included sediment grain size, prism penetration depth (a surrogate for sediment softness), aRPD, bioturbation mixing depth, presence or absence of sedimentary methane, imaged epifauna and infauna, thickness of faecal deposits, and depth of subsurface feeding voids. The imaged data were supported by a precision bathymetric survey and water column profiles of dissolved oxygen and temperature.

Results of the survey showed that the southern half of the embayment was in an intermediate-to-late stage of sediment enrichment based on the mapped OSI values. The northern and western parts of the Lettercallow had low-to-intermediate levels of degradation based on this same index. It was concluded that the pattern of benthic enrichment was related to the density of mariculture deployments and the efficiency of bay flushing as inferred from the shape of OSI contours along the bottom. Interestingly, the time-integrated record of sediment quality, as mapped by SPI data, was not closely reflected in the relatively high dissolved oxygen concentrations within the bay as measured by an oxygen meter. The SPI technique was therefore considered a more sensitive method for assessing long-term mariculture impacts on the bottom because "dissolved oxygen levels can drop to low or lethal concentrations within a few hours during periods of stratification and peak temperatures. By the time the hypoxic event is recorded with an oxygen meter (assuming a high frequency monitoring programme is in place), it is usually too late to effect a remedial management action" (O'Connor et al. 1989, p. 390).

Results of the SPI mapping resulted in temporary suspension of all mariculture activities in the Lettercallow with consideration of several options for remediation. Subsequent SPI monitoring was used to evaluate the effectiveness of remediation, and it is now a routine monitoring tool in mariculture projects in Ireland (O'Connor et al. 1991).

Success of the early application of SPI monitoring for intensive mariculture operations prompted a wider range of applications, such as monitoring of benthic impacts of finfish net pens in the Canadian Maritime Province (Wildish et al. 2003, 2004); in Cephalonia Bay, Ionian Sea (Karakassis et al. 2002); in Norway (Carroll et al. 2003); in the fjords of Pillan and Renihue in Southern Chile (Mulsow et al. 2006) and in Scotland (Solan et al. 2008). In the last case, aggregations of dead mussel shells (resulting from antibiofouling measures below individual fish pens) were a significant problem, as were shell fragments that effectively increased the mean particle size of the sediment, impeding penetration of the SPI at many of the farm locations. SPI has also been used

to evaluate the effects of mechanical harvesting of the Manila clam in the Venice Lagoon, Italy (Badino et al. 2004).

Fish trawling impact assessment

There is a large body of literature reporting on the negative impacts of bottom trawling on seafloor habitats; the Gulf States Marine Fisheries Commission's (GSMFC) *Annotated Bibliography of Fishing Impacts on Habitat* (2000, 2003) lists over 400 articles published between 1993 and 2003 addressing the physical impacts of fishing on benthic habitat and the marine environment. Given the ability of SPI to provide detail on dynamics and fine structure at the sediment-water interface, this is one area of study in which use of the technology is particularly appropriate. Disturbance impacts are most acute at the interface, particularly as a result of clam dredging and bottom trawling (Ball et al. 2000). A cursory review of the annotated bibliography (GSMFC 2000, 2003) indicated that many of the impact assessment studies have been conducted in soft-bottom environments. Most of these have relied mainly on the traditional approach involving grab or core sampling to assess potential changes in benthic community taxonomic structure, biomass or functional organization. A summary of the studies for which SPI was used to look at trawling impacts is presented in Table 3.

A significant number of the many SPI images collected during the 1990s on the soft mud bottom surrounding Hong Kong (Valente et al. 1996) showed the surface sediment layer was broken up into a thick fluidized layer with loosely interlocking mud clasts above a more consolidated sediment layer. This so-called puzzle fabric (Figure 22) was believed to be the result of sediment disturbance by extensive beam trawling that occurs throughout the waters of Hong Kong.

Nilsson & Rosenberg (2003) found that mean BHQ index values were significantly lower and more variable in trawled transects versus control transects in Gullmarsfjord, Sweden. In about 43% of the SPI images, a severe mechanical disturbance was observed, leading to increased spatial variance of the BHQ indices in trawled areas compared to control areas. Rosenberg et al. (2003a) similarly observed furrows, mud clasts, and other evidence of physical disturbance attributed to trawling in the majority of 76 SPI images taken at random in four different areas of the Gulf of Lions. In particular, epifauna and polychaete tubes were generally rare or not observed on trawled surface sediments.

The studies reported by Lindeboom & de Groot (1998) in the North Sea and Irish Sea are not extensively documented. As cited by Smith et al. (2003), Lindeboom & de Groot (1998) found physical differences in the North Sea between trawled and untrawled sites in terms of SPI penetration and roughness measurements, while in the Irish Sea, recently settled, resuspended sediments were

Table 3 Studies where SPI has been used to examine impacts of bottom trawling or clam dredging

Location	Description	Reference
Hong Kong coastal waters	Comparative surveys of trawled versus untrawled areas	Valente et al. 1996
Southern North Sea and Irish Sea	Comparative surveys of trawled versus untrawled areas	Lindeboom & de Groot 1998, Teal et al. 2009
Gullmarsfjord, Sweden	Replicated before-after experiment in three control and three trawling transects to evaluate effects of demersal shrimp trawling	Nilsson & Rosenberg 2003
Gulf of Lions, north-western Mediterranean	Surveys of four randomly located offshore areas that were presumed to be subject to trawling	Rosenberg et al. 2003b
Iraklion Bay, northern coast of Crete, southern Aegean Sea	Two sites investigated with time series to investigate the effects of otter trawling	Smith et al. 2003
Venice Lagoon, Italy	Survey to evaluate the impact of different methods used for clam harvesting	Badino et al. 2004



Figure 22 (See also Colour Figure 22 in the insert) SPI image from the inner shelf around Hong Kong showing a thick fluidized layer of loosely interlocking mud clasts comprising the upper 6-8 cm of the sediment column, with more consolidated sediment at depth. This so-called puzzle fabric resulted from the passage of a beam trawl through the surface of the soft mud.

seen as well as possible changes to sedimentary redox conditions as a result of trawling. These findings are consistent with later work by Teal et al. (2009), who documented variations in bioturbation activity and changes in sediment chemistry between regions of differential trawling impact in the North Sea. Working in the Venice Lagoon, Badino et al. (2004) found that mechanical clam harvesting by dredging decreases seabed boundary roughness and increases compaction (camera penetration was significantly lower immediately following harvesting in experimentally dredged areas). Also, comparable to Nilsson & Rosenberg's (2003) study, they found a much shallower aRPD in the images taken in the treated areas with a disturbed sediment surface. The SPI results were also consistent with grab results reported by Pranovi et al. (2003) in documenting a significant decrease in the total abundance of macrobenthic organisms following clam harvesting. Even though the digging depth of the clam harvester was only 7 cm, their results confirmed that the harvesting gear caused both direct and indirect effects extending to a depth of about 10 cm. The authors suggested that the camera would be an appropriate tool for a mesoscale study of the clam-harvesting grounds to obtain critical information for fishery management plans.

In the Aegean Sea study, Smith et al. (2003) found that small-scale seabed surface roughness and prism penetration depth by themselves were not good indicators of trawling impacts, mainly because these two SPI measurements did not distinguish between biological and anthropogenic disturbance (but see Godbold & Solan 2009 for an alternative partitioning methodology). A multivariate analysis involving a variety of physical and biological data derived from analysis of the SPI images was found to be a better indicator of trawling impacts in coarse sediments, where the lack of good penetration was compensated by the view over the sediment surface, allowing more data on surface features (tubes, organic detritus, algal or maerl presence, epifauna, track marks, etc.) to be

gathered. This multivariate approach was found to be not as effective in soft sediments. The authors noted the uncertainties that can be associated with distinguishing between trawled versus untrawled areas when the SPI camera is deployed in a blind manner. They recommended a tiered approach involving initial reconnaissance sampling with a wider area survey technique like side-scan sonar or video, followed by SPI for high-resolution imaging of surface sediments.

Valente & Pinckard (2003) performed a series of three SPI surveys in Massachusetts Bay to investigate the effects of trawl gear on soft-bottom habitats during the late summer and fall of 2002. This included an initial baseline or pre-trawl survey in August and two post-trawl surveys in October and November following intensive trawling in two areas off Scituate, Massachusetts: a lightly fished area (Little Tow) and a heavily fished area (Mud Hole). In each of these two areas, images were collected at stations aligned along trawl lanes as well as along nearby, parallel control lanes where no trawling occurred.

Overall, the images obtained in both post-trawl SPI surveys showed no significant trawling-induced changes in either physical or biological conditions at the sediment-water interface. In particular, there were no statistically significant differences in several key SPI parameters (average boundary roughness, aRPD depth, or OSI values). This lack of difference was found between the control lane versus the trawl lane stations in each survey, as well as among surveys (i.e., an absence of any detectable control-impact or before-after differences). In all cases, there were no obvious, consistent changes in the basic colour, texture or fabric of the sediment surface that would otherwise indicate physical disturbance by trawling, and delicate surface tubes continued to be visible at the sediment surface throughout the three surveys (Figure 23). The absence of any visible effects was most likely due to the same reasons (scale of sampling techniques) as the Aegean Sea study of Smith et al. (2003). Given the difference in scale between the width of the SPI prism (15 cm) compared with the scale of disturbance caused by the trawl doors or nets (metres), it would be quite easy when working in deeper water (>10 m) to miss the area of interest with either a grab or

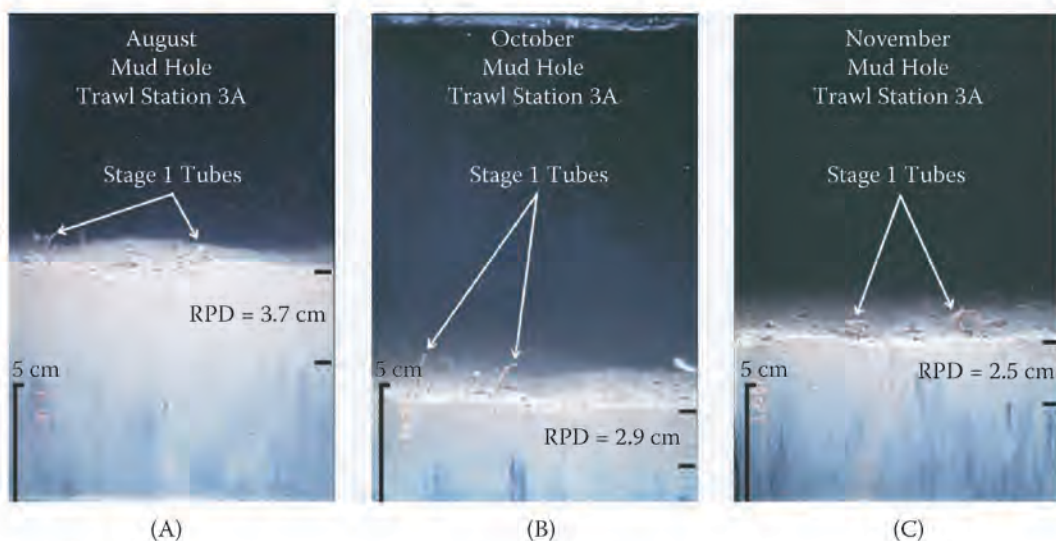

Figure 23 (See also Colour Figure 23 in the insert) Time series of profile images from a station in Massachusetts Bay characterized by silty fine sands. The August image is from the pre-trawl survey, while the October and November images are from two post-trawl surveys. Note the continued persistence through time of small stage 1 polychaete tubes at the sediment surface and a well-developed apparent redox potential discontinuity (aRPD), despite intensive trawling following the August survey.

the SPI camera. Using a plan-view camera in coordination with the SPI camera would also confirm whether or not the area of interest was indeed sampled by the associated profile image.

Bioturbation studies

The flux of porewater and sediment particles within the upper sediment column and between the sediment and overlying water due to the activities of benthic organisms has profound effects on the physical, chemical, and biological properties of sediments (Gray 1974, Rhoads 1974, Aller 1982, 1994, Rhoads & Boyer 1982). Through their feeding and burrowing activities, infauna can have an enormous influence on biogeochemical and diagenetic reactions, dramatically affect rates of contaminant flux out of the sediment, change sediment geotechnical properties, and redistribute sediment particles above or below the sediment-water interface. SPI has recently started being used in research programmes designed to understand and quantify the mechanisms of bioturbation. Building on the success of observing dynamics below the sediment-water interface in earlier time-lapse work (Diaz & Cutter 2001, Solan & Kennedy 2002), Solan et al. (2004b) used fluorescent luminophores to examine bioturbation rates *in situ* over a 16-h deployment at a location in Gullsmarsfjord, Sweden (28 m water depth). Immediately after deployment of the SPI camera and acquisition of the initial image, divers spread sand-based luminophores on the sediment surface in front of the camera prism to aid in subsequent visualization of particle movement; the layer of luminophores was restricted to within 1 cm of the faceplate and approximately 3 mm in thickness. Images were taken every 10 min over the deployment period for a total of 97 images. The use of this optical technique enables particle redistributions to be explicitly linked to discrete bioturbation events at the appropriate scales (micrometres and seconds) at which bioturbation occurs.

As with any single *in situ* measurement of biological activity, there is always some uncertainty involved as far as the amount of activity that will occur at any single random location; little infaunal bioturbation was evident below the sediment-water interface except for one brief appearance of an individual *Nephtys hombergii* at depth. In contrast to alternative methods of *in situ* tracer emplacements (e.g., chamber or core incubations), the visual evidence was available in the subsequent time-lapse sequence, allowing the observed displacement of luminophores to be directly attributed to two large epifaunal brachyuran spider crabs (*Hyas araneus*). While the results were not initially anticipated, they nonetheless represented real-world discrete behavioural mixing events that caused particle redistribution over length steps greater than diffusional differences; these discrete mixing events could be quantified and taken into account during the formalization of mathematical models of bioturbation. Despite grab sample results showing high abundances of several infaunal species that were capable of considerable levels of bioturbation (e.g., *Amphiura filiformis*, *A. chiajei*, *Nephtys hombergii*), the activities of the crabs were clearly responsible for almost all of the observed luminophore particle redistribution. The authors emphasized that consideration of behaviourally driven tracer mixing is essential over short timescales and that the adoption of a diffusive analogy for particle mixing averaged over extended time periods is likely to lead to an inaccurate classification of benthic activity.

Teal et al. (2008) examined global patterns of bioturbation intensity by assembling data on mixed-layer depths L or data on reported values for bioturbation coefficients D_b , defined as the rate at which the variance of a particle location changes over time. Both L and D_b can be determined by measuring the vertical distribution of a tracer through the sediment profile (for an overview, see Meysman et al. 2003, 2008). Values for L can also be measured directly from sediment profile images (the measured depth of the aRPD), so in addition to gathering data for L and D_b from peer-reviewed literature from 1970 to 2006, the authors gathered values for L from the SPI literature and from a variety of unpublished SPI surveys (see 'Acknowledgements' in Teal et al. (2008) for sources). The authors found little evidence for latitudinal or longitudinal effects of bioturbation, even though such trends were expected for both L and D_b given their linkage to faunal attributes

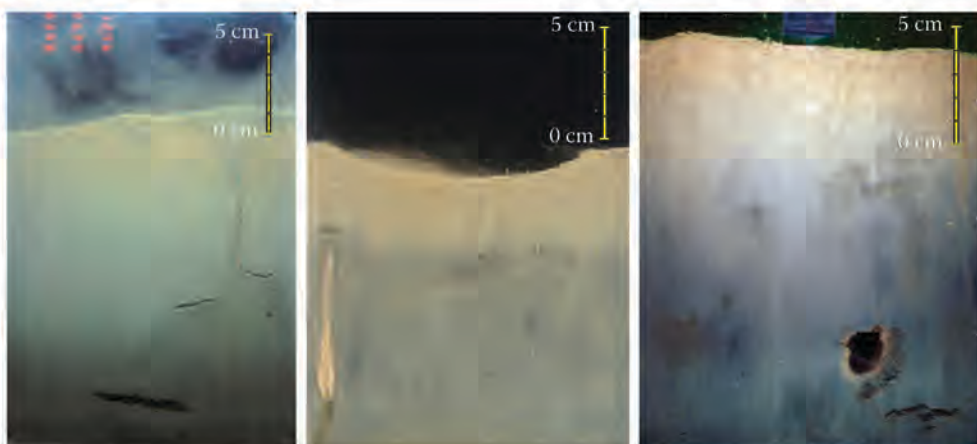

Figure 24 (See also Colour Figure 24 in the insert) These profile images show how infaunal burrowing and depth of particle mixing can extend to a much greater depth than is represented by the colour change of the lower apparent redox potential discontinuity (aRPD) boundary.

(species richness, biomass, abundance, functional groups), which vary along geographical clines. Similar trends have been documented with depth, but their assembled data showed only weak evidence that L and D_b follow similar patterns. However, they noted that the lack of evidence for these trends was not surprising given the sparse geographical spread of available data. The most important findings from their meta-analysis were the large discrepancies in estimates of both L and D_b between methods, which raised critical questions about the comparability of alternative techniques (different tracers measured over different timescales). Another striking outcome was the low values of L obtained from SPI data versus those obtained from particulate tracer studies (e.g., Wheatcroft et al. 1994, Gerino et al. 1998, Thomson et al. 2000). If one uses the aRPD depth as the lower limit of mixing, this measurement is more likely to reflect the rate of bioirrigation and sediment permeability rather than particle movement. In many cases there is evidence of burrows, voids or faunal activity below the aRPD in profile images (Figure 24), so methods used for assessing bioturbation intensities (D_b) and sediment mixing depths (L) need to be selected carefully based on their appropriateness for the objectives of the study, the processes in question, and the timescales over which they operate. Indeed, later work by the same authors (Teal et al. 2010) demonstrated that the link between the mixing depth and its driving factors (faunal mixing, food input, environmental conditions) is highly context dependent, such that it is inappropriate to draw conclusions on benthic community dynamics and ecosystem process, including assessments of habitat quality, with estimates of the mixing depth (= aRPD) alone, or indices that give particular weight to the mixed depth.

Discussion

The results from almost four decades of applied work in a wide variety of freshwater, estuarine, coastal, and offshore programmes have demonstrated the utility of SPI as a cost-effective monitoring tool that provides insights into physical and biological processes that are not readily accessible by traditional sampling methods. Benthic ecology is not known as a field in which change or rapid technological advancements normally occur (Mills 1975). Many investigators trained in traditional taxonomic methods were initially resistant to accepting this new methodology for a wide variety of reasons: lack of access to the instrumentation because of its relatively high initial cost, the unorthodox or untraditional approach of looking at soft-bottom benthic ecosystems from a more holistic framework of animal-sediment-fluid interactions, and the tendency to dismiss the technology

because the majority of applied use was outside an academic setting. However, those earlier conservative viewpoints are finally fading into the background as more monitoring initiatives and regulatory agencies are including SPI investigations as an integral part of their programmes, and more universities and government research laboratories in the United States, Europe, New Zealand and Asia are acquiring the technology and incorporating it as part of their research projects.

The key concept behind interpreting profile images is the paleoecologist's inverse methods approach: deducing dynamics from structure. Sediment profile images need to be interpreted in terms of process and context; once the data from an SPI survey have been measured from the images and mapped over the area surveyed, interpretation of the data has to be made within the context of the ecosystem or watershed in which they were collected (one would not interpret sedimentary structures seen in a freshwater river the same way one would from a coastal marine ecosystem). For example, while dissolved oxygen can only penetrate a few millimetres into silt-clay sediments through diffusional processes (Rhoads 1974), a thick layer of oxidized sediment at the surface does not necessarily always reflect bioturbational activity (Teal et al. 2010). Rapid deposition of oxidized suspended sediments can occur in rivers or flood deposits (Cutter & Diaz 2000), or strong current flow over roughness elements can also force oxygenated overlying water into the sediment beyond the diffusional mixing depth (Ziebis et al. 1996, Huettel et al. 1998). Similar to a radiologist reading an X-ray, once a 'condition diagnosis' from a series of sediment profile images has been made, additional confirmatory measurements will be required based on the questions being asked and the ecological/economic impact of the results.

The need to interpret images in terms of process and context can create real problems with blind applications of a univariate index such as the OSI or BHQ. The OSI was initially developed as a 'poor-man's GIS (geographical information system)' before GIS software was available as a way to visualize spatially distributed data. There is now little compelling need to keep calculating such an index except as an internal screening tool to highlight areas within a larger regional survey where something anomalous may be occurring and further sampling may be warranted. Blind application of either index or application of these dimensionless numbers in a regulatory context (Rosenberg et al. 2009) implies a 'value' that removes the interpretation of the data from the context of the setting in which it was collected. Both indices are strongly influenced by the depth of the aRPD, which can vary seasonally due to normal temperature variations in temperate latitudes or be influenced by depositional events and not bioturbational activities (the latter can be discerned from an examination of the profile image, whereas the aRPD score contributing to the final OSI or BHQ value would not discriminate on process). Neither index is affected by the presence of *Beggiatoa*, which has obvious implications for low dissolved oxygen stress to the benthic community. While both indices served an obvious need in the past, we find it difficult to support their continued use. Better tools exist for exploratory data analysis (GIS, scatterplots, correlation/regression coefficients, etc.) than were available 30 years ago, and there is too great a chance for misinterpretation or inappropriate use as 'bright line' index numbers in a regulatory setting. In many cases, SPI is best used as a screening tool to map gradients in physical, chemical, and biological processes or gradients, and interpretation of the images generates likely hypotheses that need to be confirmed with further testing or sampling. Interpretation and presentation of the results will be clearer if the analysis is done with the actual data measured instead of derived indices.

In addition to the applications described (dredged material management and monitoring, sediment quality investigation, habitat mapping, and monitoring impacts from aquaculture, oil drilling, offshore cable and pipeline installation, municipal sewage discharge, sand mining, trawling, pulp and paper mill effluent, and log transfer facilities), there are applications for which use of the rapid 'optical coring' technology of SPI and its ability to reveal the time-integrated record preserved in the sediment column are especially advantageous. In particular, seasonal hypoxia/anoxia has

emerged as a pressing problem that appears to be increasing in frequency in urban estuaries, coastal embayments and even coastal shelf systems like the northern Gulf of Mexico (Diaz & Rosenberg 2008). By examining the preserved signal of past anoxic events in the sediment column, investigators can get a much more accurate idea of the spatial extent and limits of anoxic impacts in benthic ecosystems than can be derived from instantaneous water column measurements (Figure 13).

In one of the earliest articles introducing the technology, Rhoads & Germano (1982) wrote that while “sediment profile imaging is not intended to eliminate grab sampling” (p. 126), the additional information gained from seeing animals in relation to their sedimentary matrix would allow scientists to deduce dynamics of physical, chemical, and biological processes from the imaged structures in the sediment cross section. Their hope was that there would be “no need for benthic ecologists to rely primarily on sampling methods used during the Challenger Expedition” (p. 127). We expect that future advances in the technology and more research in the academic arena (see next section) will make that initial hope become more of a reality.

Future directions

Before looking forward, it is always useful to briefly recap the history of events and developments that underpin current practice. The initial driving force behind the development of SPI technology was an academic interest in organism-sediment relations, with measurements disciplined by solid ecological theory and *a priori* protocols focused on *deducing dynamics from structure*. Development of the technology provided an advance in the capacity to observe and quantify processes remotely in the marine benthos, with parallels drawn between the images obtained and qualitative models of infaunal succession (Pearson & Rosenberg 1978, Rhoads et al. 1978).

However, a curious chain of events directed a somewhat singular evolution of the technology; the politics of the U.S. scientific funding agencies at the time the original profile camera was developed at Yale University created a lack of research support for this particular technology and any associated programmes. Proposals submitted to provide support through normal university channels for research on current ecological theories with SPI technology were rejected. Biological review committees explained their proposal rejection by saying that the research was too geological, while geological review committees explained their denial of funds by saying the proposed research was too biological. In the absence of interdisciplinary support that frustrated innovative research programmes (Raffaelli et al. 2005), the technology instead was adopted for use in a regulatory monitoring context because of the assumed connectivity between the latest ecological theory and the resulting SPI data. Unlike traditional monitoring methods, the unique coupling of imaging and data interpretation provided a powerful, rapid and cost-effective means of monitoring habitat condition and quality along a gradient of natural or anthropogenic impacts. What followed, particularly in the 1980s, was the development of a rudimentary means to extract information from images (computer-aided image analysis; Boyer et al. 1988, Valente et al. 1992) and a univariate index (OSI) that was amenable to the needs of regulatory authorities in that it could adequately summarize gross changes in benthic condition in space and time and reduce complex datasets to understandable linear scales (Rhoads & Germano 1982, 1986). At the time, these were turnkey solutions to replace archaic methods (Mills 1975) and allowed investigators to infer and describe complex infaunal dynamics from sediment structure.

While SPI has undoubtedly contributed to a better understanding of the complexity and dynamic nature of organism-sediment relations, even its strongest supporters would not suggest that its role has been pivotal to the understanding of community dynamics, largely due to the initial lack of research support in the academic arena. The science of predicting ecological patterns and processes from SPI has largely remained the same over the last 20 years, as has the means of data acquisition. There have been a series of relatively minor advances in image acquisition over the years (the

transition from 120 format black-and-white film to 35-mm colour slides to bulk-loaded colour film to digital SLR cameras), to a quantum leap in imaging with planar optodes (e.g., Wenzhöfer & Glud 2004, Zhu et al. 2005, 2006). For the most part, the general consensus about the standard photographic imaging SPI instrument has been aligned with the old adage, ‘if it ain’t broke, don’t fix it’.

Whether the methodology is ‘broken’ remains an open empirical question. Over the same period, few studies have concentrated on the critical evaluation of the technique itself, yet we have witnessed the emergence of a family of SPI camera systems each adapted to meet the needs of the investigator (e.g., diver operated: O’Connor et al. 1991; continuous video: Boyer & Hedrick 1989; continuous ploughing: Cutter & Diaz 1998; time lapse, Diaz & Cutter 2001, Solan & Kennedy 2002; selective imaging of specific image components: Solan et al. 2004b; deep sea: Diaz et al. 1994, Diaz 2004; removal of prism: Patterson et al. 2006; alternative means of penetration: Paavo 2007, Vopel et al. 2007, Blanpain et al. 2009; incorporation of multiple technologies: Teal et al. 2009). Efforts directed towards the serial development of SPI variants have, in effect, diverted attention away from the optimization of the design and statistical analysis of ecological field survey data and the critical evaluation of the measured parameters thought to be of ecological importance (notable exceptions include Diaz & Trefry 2006, Teal et al. 2009, Godbold & Solan 2009, Teal et al. 2010). We contend that the challenge for the future is not the development of SPI technology, but a focused attempt to understand and delineate the limitations of the system and question where its applicability lies. In short, there is a need to go back to first principles—measurements disciplined by solid ecological theory and *a priori* hypotheses that are amenable to rigorous statistical analyses.

Let us return to the issue that few studies have concentrated on, the critical evaluation of the technique itself. The main support for the validity of SPI has stemmed from a number of correlative academic studies (Germano 1983b, Keegan & Retière 1987, Hampson 1987, Ó’Céidigh 1989, Solan 2000). The largest of these took place in a number of sites in Ireland and France as part of a European Union demonstration project. A brief examination concluded that SPI was a “very powerful benthic sampling tool” that showed a “high degree of agreement” with traditionally derived data (Keegan & Retière 1987). These qualitative sentiments have also been expressed elsewhere (O’Connor et al. 1989, Rees et al. 1990, Bonsdorff et al. 1996, Gowing et al. 1997, O’Reilly et al. 2006a), but on consideration of much smaller datasets and in the absence of hypothesis-driven statistical analyses. Of more concern, however, is the lack of attention over the last 25 years to the appropriateness of the parameters actually measured for the questions that are being asked with the data. Over 30 physical, chemical, and biological parameters (Diaz & Schaffner 1988) have been put forward (many of which are collinear, confounded, or autocorrelated) that can either be inferred or directly measured from an individual SPI image. In most cases, an intuitive justification for their inclusion can be voiced, but seldom has the basis for such explanations been rigorously tested; it is hard to justify the ecological significance of some parameters, (e.g., whether the fauna present in a two-dimensional image are representative of the community; see Dorgan et al. 2005, 2006).

To illustrate this point, arguably the most routinely measured and defensible parameter in SPI images is that of the aRPD depth, based on the vertical colour change of the sediment profile from reddish-brown colour tones at the surface (oxidative state; Lyle 1983) to grey-black colour tones at depth (reducing state; Lyle 1983). The aRPD is assumed to provide a good estimate of the depth of oxidized sediment, is easily measured using standard image analysis routines, and has a pivotal weighting on determining the condition of a benthic community. It is somewhat surprising, therefore, to realize that only five scientific papers (Rosenberg et al. 2001, Cicchetti et al. 2006, Diaz & Trefry 2006; Mulsoy et al. 2006, Teal et al. 2009) have evaluated the concordance between measured dissolved oxygen, Eh profiles and image data—the earliest of these was published at the turn of the century, fully 30 years after the first SPI publication (Rhoads & Cande 1971). Even then, a correlative approach was used, and the high level of agreement (r^2 values) was taken as sufficient

to substantiate the imaging data despite only a simplistic mechanistic explanation and low levels of replication. Indeed, more substantive investigations of what constitutes and influences the depth of the aRPD have recently shown that it reflects several interacting abiotic and biotic processes that are site specific and context dependent (Teal et al. 2010), challenging previous ecological interpretations of the role of the mixed depth.

The correspondence of sediment grain size between estimates from images and distributions quantified from sieved sediment has also received some attention. In a paired blind assessment (Marine Surveys 1984), sediment grain size estimates from 39 profile images were compared *a posteriori* to results from colocated box core samples with a favorable outcome (90% agreement). However, the remaining 29 or so parameters measured from SPI images that are often purported to be ecologically meaningful have received less (or no) attention.

Grizzle & Penniman (1991) were first to recognize the need for a quantitative validation between SPI and traditional sampling methods and used an experimental approach, but their experiment suffered from inadequate replication and a lack of statistical comparison between methods. Since this analysis, however, only one peer-reviewed, published empirical study (Teal et al. 2010) has sought to calibrate or confirm the conclusions derived from SPI data. Instead, there has been a trend to use multivariate analysis to compare macrofaunal patterns obtained by traditional sampling (grabs and cores) to data simultaneously obtained by SPI (Rumohr & Karakassis 1999, O'Reilly et al. 2006a). These studies have stimulated renewed interest in verifying SPI as a technique but answer a subtly different question and have suffered from the use of reduced or incomplete datasets. Rumohr & Karakassis (1999), for example, compared SPI similarity matrices with those obtained from macrofaunal analyses at several taxonomic levels of identification. The similarity patterns produced in this study did not relate well to one another, and the authors concluded that information gained from each method was fundamentally different. However, the SPI variables included were limited in number, and over half were reduced to binary data (i.e., presence or absence); the incorrect assumption of equal variable weighting distorts the analysis, thereby increasing the chance of misinterpretation. Moreover, the use of such ground-truthing analyses falls into the trap of comparing apples and oranges, failing to recognize that SPI and grab data are independent sets of data that may or may not concur with one another because they are measuring fundamentally different attributes of the system. Instead, future emphasis should be placed on determining which parameters (if any) should be measured with SPI and whether these are sufficient to test the hypothesis under question. The underlying key issue that remains to be satisfactorily answered is not whether SPI data show concordance with other data, but whether SPI data can be substantiated as an appropriate measure of the ecosystem process of interest.

It has been argued that further work is required to extend SPI methodology into different habitats and bottom types. The development and validation of an appropriate ecological paradigm suitable for use in fresh water, the deep sea, and less-penetrable substrata may therefore seem necessary, but the desire to move into different habitats should be in response to well-defined survey objectives. Why should freshwater or deep-sea systems comply with an organic-loading model based on fjord-like coastal systems? Interestingly, in the absence of an equivalent Pearson-Rosenberg model, the few studies that have emerged in non-coastal systems have, arguably, generated better science because the necessity to address specific questions has been more pressing. Such studies are refreshing because they move away from repetitive-type surveys of the kind that populate the benthic literature (Spight 1976). Surely what is needed is an increased amount of interpretative (e.g., Boyer & Shen 1988, Cutter & Diaz 2000, Diaz 2004) rather than more descriptive SPI data in the scientific literature. Recent meetings (detailed in Kennedy 2006) seemed to confirm this view, showing that interpretation of an image varies considerably with operator. A challenge for the future is to use a more standardized and objective means of analysis that reduces the subjective evaluation of the operator and relies more on actuarial methodology (Germano 1999).

The overall objective for the future is to integrate emerging and innovative technologies from different disciplines (physics, chemistry, biology, imagery) to provide *in situ* monitoring of the sediment ecosystem to understand the complex interactions between the biota (for both their functioning and their diversity) and their sedimentary environment. Clearly SPI has a key part to play in such development, but it must be recognized that SPI does not provide the only means of obtaining *in situ* information. Ironically, many of the advances in SPI equipment have been in response to the progression of technology; a variety of low-cost probes is commercially available for the detection of an assortment of variables (e.g., oxygen, redox, pH, salinity, heavy metals, sediment shear strength), and these probes are easily modified to suit the needs of the operator. Not everything can be, or should be, quantified from only a white-light image.

Simply measuring as many (apparently) 'ecologically meaningful', but untested, parameters from an image and using multivariate analyses to 'match' data is a poor way to proceed. As with any other scientific data, SPI data are subject to the same rules that govern statistical analysis, and more advanced techniques beyond the reductionism of indices are now available, such as, generalized linear models (GLMs), generalized additive models (GAMs), generalized least squares (GLS), and mixed modelling (Crawley 2002, Quinn & Keough 2002, Zuur et al. 2007). Adopting such techniques will likely bring new insights and contribute to the next generation of ecologists. A logical next step would be to develop numerical tools to extract only the quantitative information required from the image to meet the objectives of the study (e.g., Solan et al. 2004b) and to use, if appropriate, imaging techniques that do not rely on the subjective interpretation of the operator. These should be provided in supplementary information so, in the spirit of open source, advances can be made rapidly through peer group collaboration. Finally, it will be necessary to embrace and integrate new technologies (e.g., planar optodes) so that a benthic observatory, rather than an imaging unit, can become a standard observation technology. SPI cameras allow the recognition of faunal activity, trophic relations and biodiversity; planar optodes permit one to view fields of chemical tracers such as oxygen, pH and $p\text{CO}_2$ (Fan et al. in press, Glud et al. 2001, Wenzhöfer & Glud 2004; Zhu et al. 2005, 2006); selective microelectrodes enable us to make biogeochemical measurements in the sediment at the pertinent vertical resolution (100 μm or less; Glud et al. 1999); use of fluorescent imaging filters and luminophores allow *in situ* observations and measurements of bioturbation rates (Solan et al. 2004b); and manipulated benthic chambers and gel probes exist to create controlled disturbance in the sediment and monitor the response of chemical parameters (Teal et al. 2009). Future sensor developments are anticipated and will only add to these capabilities.

These observations will need to be critically examined in the laboratory and in the field by performing controlled perturbation experiments that seek to mimic natural or human disturbances. The individual areas of expertise exist in biology, physics, geochemistry, and engineering with associated technologies; however, the integration of these disciplines is essential to provide simultaneous observations of chemical and biological variables in disturbed environments. Our hope is that funding for this type of multidisciplinary research can be found in an academic or research setting so that the kind of agency politics that hampered funding of SPI technology initially will not restrict future discoveries and innovations.

Acknowledgements

We would like to thank Dr. Thomas Fredette and the US Army Corps of Engineers, New England District, for their continued support of our work through the Disposal Area Monitoring System (DAMOS). Support for this review was provided by Contracts W912WJ-05-D-0001 and W912WJ-09-D-0003 to DAMOSVision, LLC, Newport, Rhode Island. We dedicate this review to Dr. Fredette in recognition of his many years of support for development of critical thinking about the use of SPI technology, for his good humour, and for his constructive criticism as he prodded us in our efforts to review the past 40 years of work with SPI technology.

References

- Aller, R.C. 1982. The effects of macrobenthos on chemical properties of marine sediment and overlying water. In *Animal-Sediment Relations—The Biogenic Alteration of Sediment*, P.L. McCall & M.J.S. Tevesz (eds). New York: Plenum Press, 53–102.
- Aller, R.C. 1994. Bioturbation and remineralization of sedimentary organic matter: effects of redox oscillation. *Chemical Geology* **114**, 331–345.
- Badino, G., Bona, F., Maffiotti, A., Giovanardi, O. & Pranovi, F. 2004. Impact of mechanical clam harvesting on a benthic habitat: evaluation by means of sediment profile imaging. *Aquatic Conservation Marine and Freshwater Ecosystems* **14**, S59–S67.
- Ball, B., Munday, B. & Tuck, I. 2000. Effects of otter trawling on the benthos and environment in muddy sediments. In *Effects of Fishing on Non-target Species and Habitats*, M.J. Kaiser & S.J. de Groot (eds). Oxford, UK: Blackwell Science, 69–82.
- Bekkby, T., Nilsson, H.C., Olgard, F., Rygg, B., Isachsen, P.E. & Isaeus, M. 2008. Identifying soft sediments at sea using GIS modelled predictor variables and sediment profile image (SPI) measured response variables. *Estuarine Coastal and Shelf Science* **79**, 631–636.
- Birchenough, S.N.R., Boyd, S.E., Coggan, R.A., Limpenny, D.S., Meadows, W.J. & Rees, H.L. 2006. Lights, camera and acoustics: assessing macrobenthic communities at a dredged material disposal site off the north-east coast of the UK. *Journal of Marine Systems* **62**, 204–216.
- Blanpain, O., du Bois, P.B., Cugier, P., Lafite, R., Lunven, M., Dupont, J., Le Gall, E., Legrand, J. & Pichavant, P. 2009. Dynamic sediment profile imaging (DySPI): a new field method for the study of dynamic processes at the sediment-water interface. *Limnology and Oceanography Methods* **7**, 8–20.
- Bokuniewicz, H.J., Gordon, R.B. & Rhoads, D.C. 1975. Mechanical properties of the sediment-water interface. *Marine Geology* **18**, 263–278.
- Bona, F. 2006. Effect of seaweed proliferation on benthic habitat quality assessed by Sediment Profile Imaging. *Journal of Marine Systems* **62**, 142–151.
- Bona, F., Cecconi, G. & Maffiotti, A. 2000. An integrated approach to assess the benthic quality after sediment capping in Venice lagoon. *Aquatic Ecosystem Health and Management* **3**, 379–386.
- Bona, F., Fieschi, M., Maffiotti, A. & Rhoads, D.C. 1994. Nova tecniche di monitoraggio per il controllo ambientale do lagune, estuary e mari. *Inquinamento* **7**, 60–65.
- Bonsdorff, E., Diaz, R.J., Rosenberg, R., Norkko, A. & Cutter, G.R. 1996. Characterization of soft-bottom benthic habitats of the Åland islands, northern Baltic Sea. *Marine Ecology Progress Series* **142**, 235–245.
- Borja, A., Franco, J. & Perez, V. 2000. A marine biotic index to establish the ecological quality of soft-bottom benthos within European estuarine and coastal environments. *Marine Pollution Bulletin* **40**, 1100–1114.
- Boyer, L.F. 1985. Animal-sediment interactions in marine and freshwater muddy sediments: a sediment profile camera perspective. *Estuaries* **8**, 63A.
- Boyer, L.F., Diaz, R.J. & Hedrick, J.D. 1988. Computer image-analysis techniques and video-sediment-profile camera enhancements provide a unique and quantitative view of life at or beneath the sediment-water interface. In *Proceedings of the Oceans '88 Conference*. Baltimore: Marine Technology Society, 448–453.
- Boyer, L.F. & Hedrick, J.D. 1989. Submersible deployed video sediment profile camera system for benthic studies. *Journal of Great Lakes Research* **15**, 34–45.
- Boyer, L.F. & Shen, E.J. 1988. Sediment profile camera study of Milwaukee harbour sediments. *Journal of Great Lakes Research* **14**, 444–465.
- Boyer, L.F. & Whitlatch, R.B. 1989. *In situ* studies of organism-sediment relationships in the Caribou Island Basin, Lake Superior. *Journal of Great Lakes Research* **15**, 147–155.
- Brandt, A., Gooday, A.J., Brandao, S.N., Brix, S., Brökeland, W., Cedhagen, T., Choudhury, M., Cornelius, N., Danis, B., De Mesel, I., Diaz, R.J., Gillan, D.C., Ebbe, B., Howe, J.A., Janussen, D., Kaiser, S., Linse, K., Maljutina, M., Pawlowski, J., Raupach, M. & Vanreusel, A. 2007. First insights into the biodiversity and biogeography of the Southern Ocean deep sea. *Nature* **447**, 307–311.
- Bull, D.C. & Williamson, R.B. 2001. Prediction of principal metal-binding solid phases in estuarine sediments from color image analysis. *Environmental Science and Technology* **35**, 1658–1662.
- Callier, M.D., McKindsey, C.W. & Desrosiers, G. 2008. Evaluation of indicators used to detect mussel farm influence on the benthos: two case studies in the Magdalen Islands, Eastern Canada. *Aquaculture* **278**, 77–88.

- Carey, D.A., Morris, J.T., Murray, P. & Fredette, T.J. 1997. Subaqueous capping in New England: wise use of dredged materials. In *International Workshop on Dredged Material Beneficial Uses, Baltimore, Maryland*, M.C. Landin (ed.). Vicksburg, Mississippi: U.S. Army Engineer Waterways Experiment Station, 125–126.
- Carey, D.A., Wright, C. & Esten, M.E.. 2010. Brenton Reef historic disposal site survey 2007. DAMOS Contribution No. 181. Concord, Massachusetts: U.S. Army Corps of Engineers, New England Division.
- Carroll, M.L., Cochrane, S., Fieler, R., Velvin, R. & White, P. 2003. Organic enrichment of sediments from salmon farming in Norway: environmental factors, management practices, and monitoring techniques. *Aquaculture* **226**, 165–180.
- Cicchetti, G., Latimer, J.S., Rego, S.A., Nelson, W.G., Bergen, B.J. & Coiro, L.L. 2006. Relationships between near-bottom dissolved oxygen and sediment profile camera measures. *Journal of Marine Systems* **62**, 124–141.
- Chapman, P.M. 1996. Presentation and interpretation of Sediment Quality Triad data. *Ecotoxicology* **5**, 327–339.
- Clarke, D. & Miller-Way, T. 1992. An environmental assessment of the effects of open-water disposal of maintenance dredged material on benthic resources in Mobile Bay, Alabama. Miscellaneous Paper D-92-1. Vicksburg, Mississippi: US Army Engineer Waterways Experiment Station.
- CoastalVision. 2010. Evaluation of sediment and benthos characteristics along potential cable routes and turbine locations for the proposed Block Island Wind Farm. Newport, RI. Report prepared for Deepwater Wind, Providence, Rhode Island.
- Corbett, D.R., Walsh, J.P. & Marciniak, K. 2009. Temporal and spatial variability of trace metals in sediments of two adjacent tributaries of the Neuse River Estuary, North Carolina, USA. *Marine Pollution Bulletin* **58**, 1739–1747.
- Cranfield, H.J., Rowden, A.A., Smith, D.J., Gordon, D.P. & Michael, K.P. 2004. Macrofaunal assemblages of benthic habitat of different complexity and the proposition of a model of biogenic reef habitat regeneration in Foveaux Strait, New Zealand. *Journal of Sea Research* **52**, 109–125.
- Crawley, M.J. 2002. *Statistical Computing. An Introduction to Data Analysis Using S-Plus*. London: Wiley.
- Cutter, G.R., Jr. & Diaz, R.J. 1998. Novel optical remote sensing and ground-truthing of benthic habitat using the Burrow-Cutter-Diaz plowing sediment profile camera system (BCD sled). *Journal of Shellfish Research* **17**, 1443–1444.
- Cutter, G.R., Jr. & Diaz, R.J. 2000. Biological alteration of physically structured flood deposits on the Eel margin, northern California. *Continental Shelf Research* **20**, 235–253.
- Day, M.E., Schaffner, L.C. & Diaz, R.J. 1988. Long Island Sound sediment quality survey and analyses. Final report prepared for NOAA, NOS, OMA. Rockville, Maryland: Tetra Tech.
- Diaz, R.J. 2004. Biological and physical processes structuring deep-sea surface sediments in the Scotia and Weddell Seas, Antarctica. *Deep-Sea Research II* **51**, 1515–1532.
- Diaz, R.J. & Cutter, G.R., Jr. 2001. *In situ* measurement of organism-sediment interaction: rates of burrow formation/abandonment and sediment oxidation/reduction. In *Organism-Sediment Interactions*, J.Y. Aller et al. (eds). Columbia, South Carolina: Belle W. Baruch Library in Marine Science, University of South Carolina Press, 19–32.
- Diaz, R.J., Cutter, G.R., Jr. & Dauer, D.M. 2003. A comparison of two methods for estimating the status of benthic habitat quality in the Virginia Chesapeake Bay. *Journal of Experimental Marine Biology and Ecology* **285**, 371–381.
- Diaz, R.J., Cutter, G.R., Jr. & Hobbs, C.H. 2004. Potential impacts of sand mining offshore of Maryland and Delaware: part 2—biological considerations. *Journal of Coastal Research* **20**, 61–69.
- Diaz, R.J., Cutter, G.R., Jr. & Rhoads, D.C. 1994. The importance of bioturbation to continental slope sediment structure and benthic processes off Cape Hatteras, North Carolina. *Deep-Sea Research II* **41**, 719–734.
- Diaz, R.J., Hansson, L.J., Rosenberg, R., Gapcynski, P.C. & Unger, M.A. 1993. Rapid sedimentological and biological assessment of hydrocarbon contaminated sediments. *Water Air and Soil Pollution* **66**, 251–266.
- Diaz, R.J., Neubauer, R.J., Schaffner, L.C., Pihl, L. & Baden, S.P. 1992. Continuous monitoring of dissolved oxygen in an estuary experiencing periodic hypoxia and the effect of hypoxia on macrobenthos and fish. *Science of the Total Environment* **Suppl. 1992**, 1055–1068.
- Diaz, R.J., Rhoads, D.C., Blake, J.A., Kropp, R.K. & Keay, K.E. 2008. Long-term trends of benthic habitats related to reduction in wastewater discharge to Boston Harbor. *Estuaries and Coasts* **31**, 1184–1197.

- Diaz, R.J. & Rosenberg, R. 1995. Marine benthic hypoxia: a review of its ecological effects and the behavioural responses of benthic macrofauna. *Oceanography and Marine Biology An Annual Review* **33**, 245–303.
- Diaz, R.J. & Rosenberg, R. 2008. Spreading dead zones and consequences for marine ecosystems. *Science* **321**, 926–929.
- Diaz, R.J., Rosenberg, R., Rabalais, N.N. & Levin, L.A. 2009. Dead zone dilemma. *Marine Pollution Bulletin* **58**, 1767–1768.
- Diaz, R.J. & Schaffner, L.C. 1988. Comparison of sediment landscapes in Chesapeake Bay as seen by surface and profile imaging. In *Understanding the Estuary: Advances in Chesapeake Bay Research*, Publication 129, CBP/TRS 24/88, M.P. Lynch & E.C. Krome (eds). Solomons, Maryland: Chesapeake Research Consortium, 222–240.
- Diaz, R.J., Solan, M. & Valente, R. 2004. A review of approaches for classifying benthic habitats and evaluating habitat quality. *Journal of Environmental Management* **73**, 165–181.
- Diaz, R.J. & Trefry, J.H. 2006. Comparison of sediment profile image data with profiles of oxygen and Eh from sediment cores. *Journal of Marine Systems* **62**, 164–172.
- Dorgan, K.M., Jumars, P.A., Johnson, B., Boudreau, B.P. & Landis, E. 2005. Burrow extension by crack propagation. *Nature* **433**, 475.
- Dorgan, K.M., Jumars, P.A., Johnson, B.D. & Boudreau, B.P. 2006. Macrofaunal burrowing: the medium is the message. *Oceanography and Marine Biology An Annual Review* **44**, 85–121.
- ENSR. 2007. San Francisco Deep Ocean Dredged Material Disposal Site (SF-DODS) monitoring program: September 2006. Woods Hole, Massachusetts: Final Report prepared for the Port of Oakland and the U.S. Army Corps of Engineers, San Francisco District.
- Fan, Y., Zhu, Q., Aller, R.C. & Rhoads, D.C. in press. An *in situ* multispectral imaging system for planar optodes in sediments: examples of high resolution seasonal patterns of pH. *Aquatic Geochemistry*.
- Fenchel, T. 1969. The ecology of marine microbenthos IV. Structure and function of the benthic ecosystem, its chemical and physical factors and the microfauna communities with special reference to the ciliated protozoa. *Ophelia* **6**, 1–182.
- Fredette, T.J. 1998. DAMOS: Twenty years of dredged material disposal site monitoring. Isn't that enough? *Chemistry and Ecology* **14**, 231–239.
- Fredette, T.J., Clausner, J.E., Nelson, D.A., Hands, E.B., Miller-Way, T., Adair, J.A., Sotler, V.A. & Anders, F.J. 1990. Selected tools and techniques for physical and biological monitoring of aquatic dredged material disposal sites. Technical Report D-90-11, NTIS No. AD-A229 442. Prepared for U.S. Army Engineer Waterways Experiment Station, Vicksburg, Mississippi.
- Fredette, T.J., Clausner, J.E., Palermo, M.R., Bratos, S.M., Prickett, T.L., Johnson, B.H., Brouwer, M.S., Ryan, J.A., Smith, L.J., Nevarez, E.E., Schaufler, F.K. & McDowell, S. 2002a. Field pilot study of *in situ* capping of Palos Verdes Shelf contaminated sediments. ERDC TR-02-5. Vicksburg, Mississippi: U.S. Army Engineer Research and Development Center.
- Fredette, T.J. & French, G.T. 2004. Understanding the physical and environmental consequences of dredged material disposal: history in New England and current perspectives. *Marine Pollution Bulletin* **49**, 93–102.
- Fredette, T.J., Germano, J.D., Carey, D.A., Murray, P.M. & Kullberg, P. 1992. Chemical stability of capped dredged material disposal mounds in Long Island Sound, USA. *Chemistry and Ecology* **7**, 173–194.
- Fredette, T.J., Jackson, P.E., Rogers, C.J., Hadden, D.A., Wolf, S.H., Nowak, T.A., Jr. & DeAngelo, E. 2002b. Monitoring results from the Boston Harbor Navigation Improvement Project Confined Aquatic Disposal Cells. In *Dredged Material Management—Options and Environmental Considerations*, Proceedings of a Conference, December 3–6, 2000, J. Pederson & E.E. Adams (eds). Cambridge, Massachusetts: MIT Sea Grant College Program, Massachusetts Institute of Technology, 3–10.
- Fyfe, J.A., Shaw, R., Campbell, S.D.G., Lai, K.W. & Kirk, P.A. 2000. *The Quaternary Geology of Hong Kong*. Kowloon, Hong Kong: Geotechnical Engineering Office, Civil Engineering Department, the Government of Hong Kong Special Administrative Region.
- Gerino, M., Aller, R.C., Lee, C., Cochran, J.K., Aller, J.Y., Green, M.A. & Hirschberg, D. 1998. Comparison of different tracers and methods used to quantify bioturbation during a spring bloom: 234-thorium, lumino-phores and chlorophyll *a*. *Estuarine Coastal and Shelf Science* **46**, 531–547.
- Germano & Associates, Inc. 2001. Sediment profile imaging survey: Daya Bay, Guangdong Province, People's Republic of China, September 27–October 1, 2001. Bellevue, Washington: Final report prepared for Arthur D. Little, Ltd., Cambridge, UK.

- Germano & Associates, Inc. 2002. Sediment profile imaging survey in the Gulf of Mexico. Bellevue, Washington: Final report prepared for R.J. Diaz & Daughters.
- Germano & Associates, Inc. 2004. The effects of seafood waste discharges on the benthic environment at Ketchikan, Alaska. Bellevue, Washington: Final report prepared for Tetra Tech, Inc.
- Germano & Associates, Inc. 2010. Evaluation of sediment and benthos characteristics at the completed northern pipeline route for the Neptune deepwater port location in Massachusetts Bay, USA: first post-construction survey. Bellevue, Washington: Final report prepared for Ecology & Environment, Inc.
- Germano, J.D. 1983a. High resolution sediment profiling with REMOTS® camera system. *Sea Technology* **24**, 35–41.
- Germano, J.D. 1983b. *Infaunal succession in Long Island Sound: animal-sediment interactions and the effects of predation*. PhD dissertation, Yale University, New Haven, CT.
- Germano, J.D. 1994. Environmental mediation and open water disposal. In *Dredging '94. Proceedings of the Second International Conference on Dredging and Dredged Material Placement*, E. Clark McNair, Jr. (ed.). New York: American Society of Civil Engineers, 160–169.
- Germano, J.D. 1995. Sediment profile imaging: a rapid seafloor impact assessment tool for oil spills. In *Proceedings of the Eighteenth Arctic and Marine Oil Spill Program (AMOP) Technical Seminar*, M. Fingus (ed.). Ottawa, Ontario, Canada: Environment Canada, 1271–1279.
- Germano, J.D. 2003. Designing borrow pit CAD sites: remember Newton's Third Law! In *Proceedings of the Western Dredging Association Twenty-Third Technical Conference*, CDS Report No. 376 [CD], R.E. Randall (ed.). College Station, Texas: Center for Dredging Studies, Texas A&M University, 302–312.
- Germano, J.D. 1999. Ecology, statistics, and the art of misdiagnosis: the need for a paradigm shift. *Environmental Reviews* **7**, 167–190.
- Germano, J.D. & Browning, D.G. 2006. Marine log transfer facilities and wood waste: when dredging is not your final answer. In *Proceedings of the Western Dredging Association Twenty-Sixth Technical Conference. June 25–28, 2006, San Diego, CA* [CD], R.E. Randall (ed.). College Station, Texas: Center for Dredging Studies, Texas A&M University.
- Germano, J.D. & Read, L.B. 2002. Natural recovery at a submarine wood waste site. In *Remediation and Beneficial Reuse of Contaminated Sediments. Proceedings of the First International Conference on Remediation of Contaminated Sediments, Venice, Italy, October 10–12, 2001*, R.E. Hinchey et al. (eds). Columbus, Ohio: Battelle Memorial Institute Press, 395–402.
- Germano, J.D., Read, L.B., Myre, P.L., Valente, R.M., Rhoads, D.C., Solan, M. & Carey, D.A. In preparation. Through a glass darkly: Comparing results from sediment-profile images (SPI) and grab samples. *Journal of Marine Research*.
- Germano, J.D., Reid, C.A., Whiteside, P.G.D. & Kennish, R. 2002. Field verification of computer models predicting plume dispersion in Hong Kong. In *Dredging '02. Key Technologies for Global Prosperity, Proceedings of the Third Specialty Conference on Dredging and Dredged Material Disposal, May 5–8, 2002* [CD], S. Garbaciak, Jr. (ed.). Orlando, Florida: American Society of Civil Engineers (ASCE).
- Germano, J.D. & Rhoads, D.C. 1984. REMOTS® sediment profiling at the field verification program (FVP) disposal site. In *Dredging and Dredged Material Disposal Proceedings*, Volume 1, R.L. Montgomery & J.W. Leach (eds). New York: American Society of Civil Engineers, 536–544.
- Germano, J.D., Rhoads, D.C., Boyer, L.F., Menzie, C.A. & Ryther, J.A., Jr. 1989. REMOTS® imaging and side-scan sonar: efficient tools for mapping sea floor topography, sediment type, bedforms, and biology. In *Oceanic Processes in Marine Pollution. Volume 4: Scientific Monitoring Strategies for Ocean Waste Disposal*, D.W. Hood et al. (eds). Malabar, Florida: Krieger, 39–48.
- Germano, J.D., Rhoads, D.C. & Lunz, J.D. 1994. An integrated, tiered approach to monitoring and management of dredged material disposal sites in the New England region. *DAMOS Contribution No. 87*. Waltham, Massachusetts: U.S. Army Corps of Engineers, New England Division.
- Glud, R.N., Klimant, I., Holst, G., Kohls, O., Meyer, V., Kuhl, M. & Gundersen, J.K. 1999. Adaptation, test and *in situ* measurements with O₂ microopt(r)odes on benthic landers. *Deep-Sea Research* **46**, 171–183.
- Glud, R.N., Tengberg, A., Kuhl, M., Hall, P.O.J. & Klimant, I. 2001. An *in situ* instrument for planar O₂ optode measurements at benthic interfaces. *Limnology and Oceanography* **46**, 2073–2080.
- Godbold, J.A. & Solan, M. 2009. Relative importance of biodiversity and the environment in mediating ecosystem process. *Marine Ecology Progress Series* **396**, 281–290.

- Gowing, L., Priestley, S. & Kennedy, P. 1997. Monitoring the Hauraki Gulf dredgings disposal site using REMOTS® and other established sampling techniques. In *Pacific Coasts and Ports '97: Proceedings of the 13th Australasian Coastal and Ocean Engineering Conference and the 6th Australasian Port and Harbour Conference, Volume 2*. Christchurch, NZ: Centre for Advanced Engineering, University of Canterbury, 1997, 882–887.
- Gray, J.S. 1974. Animal-sediment relationships. *Oceanography and Marine Biology An Annual Review* **12**, 223–261.
- Greges, M. 1994. Ocean disposal with capping of dioxin contaminated sediment: New York case history #1. In *Dredging '94: Proceedings of the Second International Conference on Dredging and Dredged Material Placement*, E.C. McNair, Jr. (ed.). New York: American Society of Civil Engineers, 1278–1284.
- Grehan, A.J., Keegan, B.F., Bhaud, M. & Guille, A. 1992. Sediment profile imaging of soft substrates in the western Mediterranean—the extent and importance of faunal reworking. *Comptes Rendus de l'Academie des Sciences Serie II I-Sciences de la Vie—Life Sciences* **315**, 309–315.
- Grizzle, R.E. & Penniman, C.A. 1991. Effects of organic enrichment on estuarine macrofaunal benthos: a comparison of sediment profile imaging and traditional methods. *Marine Ecology Progress Series* **74**, 249–262.
- Gulf States Marine Fisheries Commission (GSMFC). 2000. Annotated bibliography of fishing impacts on habitat—October 2000 update. In Gulf States Marine Fisheries Commission Publication No. 78, J.K. Rester (ed.). Ocean Springs, Mississippi. Available HTTP: <http://www.gsmfc.org/pubs/Habitat/fishingimpacts10-00.pdf> (accessed 10 September 2010).
- Gulf States Marine Fisheries Commission (GSMFC). 2003. Annotated bibliography of fishing impacts on habitat—September 2003 update. In Gulf States Marine Fisheries Commission Publication No. 115, J.K. Rester (ed.). Ocean Springs, Mississippi. Available HTTP: <http://www.gsmfc.org/pubs/Habitat/fishingimpacts9-03.pdf> (accessed 10 September 2010).
- Hampson, G.R. 1987. Ground truth verification of a REMOTS® survey of Buzzards Bay. Woods Hole, Massachusetts: Final draft report prepared for U.S. Environmental Protection Agency, Region I, Water Management Division.
- Howe, J.A., Shimmiel, T.M. & Diaz, R.J. 2004. Deep-water sedimentary environments of the northwestern Weddell Sea and South Sandwich Islands, Antarctica. *Deep-Sea Research II* **51**, 1489–1514.
- Howe, J.A., Wilson, C.R., Shimmiel, T.M., Diaz, R.J. & Carpenter, L.W. 2007. Recent deep-water sedimentation, trace metal and radioisotope geochemistry across the Southern Ocean and Northern Weddell Sea, Antarctica. *Deep-Sea Research II* **54**, 1652–1681.
- Huettel, M., Ziebis, W., Forster, S., & Luther, G.W., III. 1998. Advective transport affecting metal and nutrient distributions and interfacial fluxes in permeable sediments. *Geochimica et Cosmochimica Acta* **62**, 613–631.
- Hyypä, J., Hyypä, H., Inkinen, M., Engdahl, M., Linko, S. & Zhu, Y.-H. 2000. Accuracy comparison of various remote sensing data sources in the retrieval of forest stand attributes. *Forest Ecology and Management* **128**, 109–120.
- Iocco, L.E., Stevenson, B. & Diaz, R.J. 2000a. Apalachicola Bay Benthic Mapping Project October 1999: data report. Charleston, South Carolina: NOAA Coastal Services Center.
- Iocco, L.E., Wilber, P., Diaz, R.J., Clarke, D.G. & Will, R.J. 2000b. *Benthic habitats of New York/New Jersey Harbor: 1995 Survey of Jamaica, Upper, Newark, Bowery, and Flushing Bays*. Charleston, South Carolina: NOAA Coastal Services Center.
- Johnson, R.G. 1972. Conceptual models of benthic marine communities. In *Models in Paleobiology*, T.J.M. Schopf (ed.). San Francisco: Freeman, Cooper & Co., 149–159.
- Josefson, A.B., Forbes, T.L. & Rosenberg, R. 2002. Fate of phytodetritus in marine sediments: functional importance of macrofaunal community. *Marine Ecology Progress Series* **230**, 71–85.
- Karakassis, I., Tsapakis, M., Smith, C.J. & Rumohr, H. 2002. Fish farming impacts in the Mediterranean studied through sediment profiling imagery. *Marine Ecology Progress Series* **227**, 125–133.
- Keegan, B.F. & Retière, C. 1987. Marine pollution. Environmental monitoring of soft sea floors by means of electronic imaging of the sediment profile. Galway, Ireland: Summary report on Contract No. B-04-08, Commission of the European Communities.
- Keegan, B.F., Rhoads, D.C., Germano, J.D., Solan, M., Kennedy, R., O'Connor, I., O'Connor, B., McGrath, D., Dinneen, P., Acevedo, S., Young, S., Grehan, A. & Costelloe, J. 2001. Sediment profile imagery (SPI) as a benthic monitoring tool—introduction to a long term case history evaluation (Galway Bay, west coast

- of Ireland). In *Organism-Sediment Interactions*, J.Y. Aller et al. (eds). Columbia, South Carolina: Belle W. Baruch Library in Marine Science, University of South Carolina Press, 43–62.
- Kennedy, J.J. 1995. The courtship, pseudo-copulation behavior and spermatophore of *Turritella communis* Risso 1826 (Prosobranchia, Turritellidae). *Journal of Molluscan Studies* **61**, 421–434.
- Kennedy, R. 2006. Introduction to the proceedings of the Sediment Profile Imagery Colloquium of Experts (SPICE). *Journal of Marine Systems* **62**, 121–123.
- Lindeboom, H.J. & S.J. de Groot (eds). 1998. *IMPACT II—the effects of different types of fisheries on the North Sea and Irish Sea benthic ecosystems*. Rapport 1998(1). Den Burg, Texel (the Netherlands): NIOZ.
- Lyle, M. 1983. The brown-green colour transition in marine sediments: a marker of the Fe(III)–Fe(II) redox boundary. *Limnology and Oceanography* **28**, 1026–1033.
- Makra, A., Thessalou-Legaki, M., Costelloe, J., Nicolaidou, A. & Keegan, B.F. 2001. Mapping the pollution gradient of the Saronikos Gulf benthos prior to the operation of the Athens sewage treatment plant, Greece. *Marine Pollution Bulletin* **42**, 1417–1419.
- Marine Surveys. 1984. Chesapeake Bay Disposal Sites Survey: REMOTS® Baseline Monitoring. February 1984. New Haven, Connecticut: final report prepared for Virginia Institute of Marine Science, Gloucester Point, VA.
- Mascarelli, A. 2010. Deepwater Horizon: after the oil. *Nature* **467**, 22–24.
- Mayor, D.J., Zuur, A.F., Solan, M., Paton, G.I. & Killham, K. 2010. Factors affecting benthic impacts at Scottish fish farms. *Environmental Science and Technology* **44**, 2079–2084.
- McDowell, S.E., May, B. & Pabst, D. 1994. The dioxin capping project at the NY Mud Dump Site. In *Dredging '94: Proceedings of the Second International Conference on Dredging and Dredged Material Placement*, E.C. McNair, Jr. (ed.). New York: American Society of Civil Engineers, 1270–1277.
- Meysman, F.J.R., Boudreau, B. & Middelburg, J.J. 2003. Relations between local, non-local, discrete and continuous models of bioturbation. *Journal of Marine Research* **61**, 391–410.
- Meysman, F.J.R., Malyuga, V.S., Boudreau, B.P. & Middelburg, J.J. 2008. Quantifying particle dispersal in aquatic sediments at short time scales: model selection. *Aquatic Biology* **2**, 239–254.
- Mills, E.L. 1975. Benthic organisms and the structure of marine ecosystems. *Journal of the Fisheries Research Board of Canada* **32**, 1657–1663.
- Mulsow, S., Krieger, Y. & Kennedy, R. 2006. Sediment profile imaging (SPI) and micro-electrode technologies in impact assessment studies: example from two fjords in Southern Chile used for fish farming. *Journal of Marine Systems* **62**, 152–163.
- Nammalwar, P., Ghita, O. & Whelan, P.F. 2010. A generic framework for colour texture segmentation. *Sensor Review* **30**, 69–79.
- Nestlerode, J.A. & Diaz, R.J. 1998. Effects of periodic environmental hypoxia on predation of a tethered polychaete, *Glycera americana*: implication for trophic dynamics. *Marine Ecology Progress Series*. **172**, 185–195.
- Newell, R.C., Seiderer, L.J. & Hitchcock, D.R. 1998. The impact of dredging works in coastal waters: a review of the sensitivity to disturbance and subsequent recovery of biological resources on the sea bed. *Oceanography and Marine Biology An Annual Review* **36**, 127–178.
- Nichols, M., Diaz, R.J. & Schaffner, L.C. 1990. Effects of Hopper dredging and sediment dispersion, Chesapeake Bay. *Environmental Geology and Water Science* **15**, 31–43.
- Nilsson, H.C. & Rosenberg, R. 1997. Benthic habitat quality assessment of an oxygen stressed fjord by surface and sediment profile images. *Journal of Marine Systems* **11**, 249–264.
- Nilsson, H.C. & Rosenberg, R. 2000. Succession in marine benthic habitats and fauna in response to oxygen deficiency: analysed by sediment profile-imaging and by grab samples. *Marine Ecology Progress Series* **197**, 139–149.
- Nilsson, H.C. & Rosenberg, R. 2003. Effects on marine sedimentary habitats of experimental trawling analysed by sediment profile imagery. *Journal of Experimental Marine Biology and Ecology* **285**, 453–463.
- Nixon, S. 1990. Marine eutrophication: a growing international problem. *Ambio* **19**, 101.
- Ó'Céidigh, E. 1989. *A comparison of sediment profile imagery and traditional macrofaunal sampling methods in pollution effects monitoring of marine sediments*. MSc thesis, Department of Zoology, National University of Ireland, Galway, Ireland.
- O'Connor, B., Hartnett, M. & Costelloe, J. 1991. Site selection and environmental monitoring in the mariculture industry: an integrated protocol. In *Aquaculture and the Environment*, N. De Pauw & J. Joyce (eds). Ghent, Belgium: European Aquaculture Special Publication No. 16, pp. 191–202.

- O'Connor, B.D.S., Costelloe, J., Keegan, B.F. & Rhoads, D.C. 1989. The use of REMOTS® technology in monitoring coastal enrichment resulting from mariculture. *Marine Pollution Bulletin* **20**, 384–390.
- O'Reilly, R., Kennedy, R., Patterson, A. & Keegan, B.F. 2006a. Ground truthing sediment profile imagery with traditional benthic survey data along an established disturbance gradient. *Journal of Marine Systems* **62**, 189–203.
- O'Reilly, R., Kennedy, R. & Patterson, A. 2006b. Destruction of conspecific bioturbation structures by *Amphiura filiformis* (Ophiuroida): evidence from luminophore tracers and *in situ* timelapse sediment profile imagery. *Marine Ecology Progress Series* **315**, 99–111.
- Paavo, B.L. 2007. *Soft-sediment benthos of Aramoana and Blueskin Bay (Otago, New Zealand) and effects of dredge-spoil disposal*. PhD thesis, University of Otago Department of Marine Science, Dunedin, New Zealand.
- Palermo, M.R., Clausner, J.E., Rollings, M.P., Williams, G.L., Myers, T.E., Fredette, T.J. & Randall, R.E. 1998. Guidance for subaqueous dredged material capping. Technical Report DOER-1. Vicksburg, Mississippi: Dredging Operations and Environmental Research Program, U.S. Army Corps of Engineers, Waterways Experiment Station.
- Patterson, A., Kennedy, R., O'Reilly, R. & Keegan, B.F. 2006. A field test of a low cost novel scanner based sediment profile imaging camera. *Limnology and Oceanography Methods* **4**, 30–37.
- Pearson, T.H. & Rosenberg, R. 1978. Macrobenthic succession in relation to organic enrichment and pollution of the marine environment. *Oceanography and Marine Biology An Annual Review* **16**, 229–311.
- Pequegnat, W.E., Gallaway, B.J. & Wright, T.D. 1990. Revised procedural guide for designation surveys of ocean dredged material disposal sites. Technical Report D-90-8 prepared for Waterways Experiment Station, U.S. Army Corps of Engineers, Vicksburg, MS.
- Petersen, C.G.J. 1913. Valuation of the sea. II. The animal communities of the sea-bottom and their importance for marine zoogeography. *Report Danish Biological Station* **21**, 1–44.
- Pranovi, F., Da Ponte, F., Raicevich, S. & Giovanardi, O. 2003. A synoptic-multidisciplinary study of the immediate effects of mechanical clam-harvesting in the Venice Lagoon. *ICES Journal of Marine Science* **61**, 43–52.
- Quinn, G.P. & Keough, M.J. 2002. *Experimental Design and Data Analysis for Biologists*. Cambridge, UK: Cambridge University Press.
- Raffaelli, D., Solan, M. & Webb, T.J. 2005. Do marine and terrestrial ecologists do it differently? *Marine Ecology Progress Series* **304**, 283–289.
- Rees, H.L., Moore, D.C., Pearson, T.H., Elliott, M., Service, M., Pomfret, J. & Johnson, D. 1990. Procedures for the monitoring of marine benthic communities at UK sewage sludge disposal sites. Scottish Fisheries Information 18. Department of Agriculture and Fisheries for Scotland. Available HTTP: <http://www.Scotland.gov.uk/Uploads/Documents/No%2018.pdf> (accessed 17 February 2011).
- Reish, D.J. 1955. The relation of polychaetous annelids to harbor pollution. *Public Health Reports* **70**, 1168–1174.
- Revelas, E.C., Germano, J.D. & Rhoads, D.C. 1987a. REMOTS®: Reconnaissance of benthic environments. In *Coastal Zone '87*, O.T. Magoon et al. (eds). New York: American Society of Civil Engineers, 2069–2083.
- Revelas, E.C., Rhoads, D.C. & Germano, J.D. 1987b. San Francisco Bay Sediment Quality Survey and Analysis. NOAA Technical Memorandum NOS/OMA 35. Rockville, Maryland: NTIS.
- Rhoads, D.C. 1970. Mass properties, stability, and ecology of marine muds related to burrowing activity. In *Trace Fossils*, Geology Journal Special Issue #3, T.P. Crimes & J.C. Harper (eds). Liverpool, UK: Seel House Press, 391–406.
- Rhoads, D.C. 1974. Organism-sediment relations on the muddy seafloor. *Oceanography and Marine Biology An Annual Review* **12**, 263–300.
- Rhoads, D.C. 1995. Measuring hydrocarbon contaminants of the seafloor. *Sea Technology* **36**, 37–42.
- Rhoads, D.C. & Boyer, L.F. 1982. The effects of marine benthos on physical properties of sediments. In *Animal-Sediment Relations—The Biogenic Alteration of Sediments*, P.L. McCall & M.J.S. Tevesz (eds). New York: Plenum Press, 3–52.
- Rhoads, D.C. & Cande, S. 1971. Sediment profile camera for *in situ* study of organism-sediment relations. *Limnology and Oceanography* **16**, 110–114.
- Rhoads, D.C. & Germano, J.D. 1982. Characterisation of organism-sediment relations using sediment profile imaging: an efficient method of remote ecological monitoring of the seafloor (REMOTS™ system). *Marine Ecology Progress Series* **8**, 115–128.

- Rhoads, D.C. & Germano, J.D. 1986. Interpreting long-term changes in benthic community structure: a new protocol. *Hydrobiologia* **142**, 291–308.
- Rhoads, D.C. & Germano, J.D. 1990. The use of REMOTS imaging technology for disposal site selection and monitoring. In *Geotechnical Engineering of Ocean Waste Disposal*, K.R. Demars & R.C. Chaney (eds). Philadelphia: American Society for Testing and Materials ASTM STP 1087, 50–64.
- Rhoads, D.C., McCall, P.L. & Yingst, J.Y. 1978. Disturbance and production on the estuarine seafloor. *American Scientist* **66**, 577–586.
- Rhoads, D.C., Mulsow, S.G., Gutschick, R., Baldwin, C.T. & Stolz, J.F., 1991. The dysaerobic zone revisited: a magnetic facies. In: *Modern and Ancient Continental Shelf Anoxia*. Tyson, R.V. & T.H. Pearson (eds). London: Geological Society Special Publication, 187–199.
- Rhoads, D.C., Valente, R., Germano, J.D., Hilbig, B., Hodgson, G. & Evans, N. 1995. REMOTS® monitoring of dredging, disposal, sand mining, and organic enrichment on the Hong Kong shelf. In *Oceans '95 Conference Proceedings, October 9–12, San Diego, CA*. Washington, DC: Marine Technology Society, 918–924.
- Rhoads, D.C. & Young, D.K. 1970. The influence of deposit-feeding organisms on sediment stability and community trophic structure. *Journal of Marine Research* **28**, 150–178.
- Rhoads, D.C. & Young, D.K. 1971. Animal sediment relations in Cape Cod Bay, Massachusetts. II. Reworking by *Molpadia oolitica* (Holothuroidea). *Marine Biology* **11**, 255–261.
- Rosenberg, R. 1985. Eutrophication—the future marine coastal nuisance? *Marine Pollution Bulletin* **16**, 227–231.
- Rosenberg, R. 1990. Negative oxygen trends in Swedish coastal bottom waters. *Marine Pollution Bulletin* **21**, 335–339.
- Rosenberg, R. 1995. Benthic marine fauna structured by hydrodynamic processes and food availability. *Netherlands Journal of Sea Research* **34**, 303–317.
- Rosenberg, R. 2001. Marine benthic faunal successional stages and related sedimentary activity. *Scientia Marina* **65**, 107–119.
- Rosenberg, R., Agrenius, S., Hellman, B., Nilsson, H.C. & Norling, K. 2002. Recovery of marine benthic habitats and fauna in a Swedish fjord following improved oxygen conditions. *Marine Ecology Progress Series* **234**, 43–53.
- Rosenberg, R., Blomqvist, M., Nilsson, H.C., Cederwall, H. & Dimming, A. 2004. Marine quality assessment by use of benthic species-abundance distributions: a proposed new protocol within the European Union Water Framework Directive. *Marine Pollution Bulletin* **49**, 728–739.
- Rosenberg, R. & Diaz, R.J. 1993. Sulfur bacteria (*Beggiatoa* spp.) mats indicate hypoxic conditions in the inner Stockholm Archipelago. *Ambio* **22**, 32–36.
- Rosenberg, R., Gremare, A., Amouroux, J.M. & Nilsson, H.C. 2003a. Benthic habitats in the northwest Mediterranean characterized by sedimentary organics, benthic macrofauna and sediment profile images. *Estuarine Coastal and Shelf Science* **57**, 297–311.
- Rosenberg, R., Loo, L.-O. & Möller, P. 1992. Hypoxia, salinity and temperature as structuring factors for marine benthic communities in an eutrophic area. *Netherlands Journal of Sea Research* **30**, 121–129.
- Rosenberg, R., Magnusson, M. & Nilsson, H.C. 2009. Temporal and spatial changes in marine benthic habitats in relation to the EU Water Framework Directive: the use of sediment profile imagery. *Marine Pollution Bulletin* **58**, 565–572.
- Rosenberg, R. & Nilsson, H.C. 2005. Deterioration of soft-bottom benthos along the Swedish Skagerrak Coast. *Journal of Sea Research* **54**, 231–242.
- Rosenberg, R., Nilsson, H.C. & Diaz, R.J. 2001. Response of benthic fauna and changing sediment redox profiles over a hypoxic gradient. *Estuarine Coastal and Shelf Science* **53**, 343–350.
- Rosenberg, R., Nilsson, H.C., Gremare, A. & Amouroux, J.M. 2003b. Effects of demersal trawling on marine sedimentary habitats analysed by sediment profile imagery. *Journal of Experimental Marine Biology and Ecology* **285**, 465–477.
- Rosenberg, R., Nilsson, H.C., Hellman, B. & Agrenius, S. 2000. Depth correlated benthic faunal quantity and infaunal burrow structures on the slopes of a marine depression. *Estuarine Coastal and Shelf Science* **50**, 843–853.
- Rosenberg, R., Svensson, A., Nilsson, H.C. & Pettersson, G. 1999. Benthic habitat quality assessment in Asfjorden, Lake Vanern, by sediment profile imaging [in Swedish with English summary]. *Vatten* **55**, 83–87.

- Rumohr, H. 1995. Monitoring the marine environment with imaging methods. *Scientia Marina* **59**, 129–138.
- Rumohr, H., Bonsdorff, E. & Pearson, T.H. 1996. Zoobenthic succession in Baltic sedimentary habitats. *Archives of Fisheries and Marine Research* **44**, 179–214.
- Rumohr, H. & Karakassis, I. 1999. Comparison of multivariate patterns: different taxonomic levels in macrofaunal analysis versus sediment profiling imagery (SPI). *Marine Ecology Progress Series* **190**, 125–132.
- Rumohr, H. & Schomann, H. 1992. REMOTS sediment profiles around an exploratory drilling rig in the southern North Sea. *Marine Ecology Progress Series* **91**, 303–311.
- Schaffner, L.C. 1990. Small-scale organism distributions and patterns of species diversity: evidence for positive interactions in an estuarine benthic community. *Marine Ecology Progress Series* **61**, 107–117.
- Schaffner, L.C., Jonsson, P., Diaz, R.J., Rosenberg, R. & Gapcynski, P. 1992. Benthic communities and bioturbation history of estuarine and coastal systems: effects of hypoxia and anoxia. *Science of the Total Environment* **Suppl. 1992**, 1001–1016.
- Science Applications International Corporation (SAIC). 1987. REMOTS reconnaissance mapping of near-bottom dissolved oxygen: central to western Long Island Sound August 1986. Boston: Prepared for U.S. EPA Region I, Water Management Division, SAIC Report No. 87/7502&132.
- Science Applications International Corporation (SAIC). 1988. REMOTS reconnaissance mapping of near-bottom dissolved oxygen: central to western Long Island Sound August 1987. Boston: Prepared for U.S. EPA Region I, Water Management Division, SAIC Report No. 88/7502&175.
- Science Applications International Corporation (SAIC). 1995. Sediment capping of subaqueous dredged material disposal mounds: an overview of the New England experience 1979–1993 (Special Technical Report). DAMOS Contribution No. 95. Waltham, Massachusetts: U.S. Army Corps of Engineers, New England Division.
- Science Applications International Corporation (SAIC). 1996. San Francisco Deep Ocean Dredged Material Disposal Site (SF-DODS) Monitoring Program. Physical, chemical, and benthic community monitoring, January 1996. Newport, Rhode Island: Science Applications International Corporation, final report prepared for U.S. Army Corps of Engineers, San Francisco District, San Francisco, CA.
- Science Applications International Corporation (SAIC). 2001. Monitoring cruise at the New London disposal site, Volume 2, Seawolf Mound, 1995–1998. DAMOS Contribution No. 132. Concord, Massachusetts: U.S. Army Corps of Engineers, New England District.
- Science Applications International Corporation (SAIC). 2003a. The Massachusetts Bay disposal site capping demonstration project, 1998–2000. DAMOS Contribution No. 147. Concord, Massachusetts: U.S. Army Corps of Engineers, New England District.
- Science Applications International Corporation (SAIC). 2003b. Monitoring survey over Boston Harbor CAD Cell M19. DAMOS Contribution No. 148. Concord, Massachusetts: U.S. Army Corps of Engineers, New England District.
- Science Applications International Corporation (SAIC). 2003c. Results of the summer 2002 monitoring surveys of the 1993 Dioxin Capping Project mound at the Historic Area Remediation Site. SAIC Report No. 622. Newport, Rhode Island: Science Applications International Corporation, final report prepared for U.S. Army Corps of Engineers, New York District.
- Science Applications International Corporation (SAIC). 2003d. Results of the summer 2002 monitoring surveys of the 1997 Category II Capping Project mound at the Historic Area Remediation Site. SAIC Report No. 626. Newport, Rhode Island: Science Applications International Corporation, final report prepared for U.S. Army Corps of Engineers, New York District.
- Shumchenia, E.J. & King, J.W. 2010. Evaluation of sediment profile imagery as a tool for assessing water quality in Greenwich Bay, Rhode Island, USA. *Ecological Indicators* **10**, 818–825.
- Simboura, N., Zenetos, A., Panagiotidis, P. & Makra, A. 1995. Changes in benthic community structure along an environmental pollution gradient. *Marine Pollution Bulletin* **30**, 470–474.
- Smith, C.J., Rumohr, H., Karakassis, I. & Papadopoulou, K.N. 2003. Analysing the impact of bottom trawls on sedimentary seabeds with sediment profile imagery. *Journal of Experimental Marine Biology and Ecology* **285**, 479–496.
- Snelgrove, P.V.R. & Butman, C.A. 1994. Animal-sediment relationships revisited—cause versus effect. *Oceanography and Marine Biology An Annual Review* **32**, 111–177.
- Solan, M. 2000. *The concerted use of 'traditional' and sediment profile imagery (SPI) methodologies in marine benthic characterisation and monitoring*. PhD dissertation, the National University of Ireland, Galway, Ireland.

- Solan, M., Cardinale, B.J., Downing, A.L., Engelhardt, K.A.M., Ruesink, J.L. & Srivastava, D.S. 2004a. Extinction and ecosystem function in the marine benthos. *Science* **306**, 1177–1180.
- Solan, M., Germano, J.D., Rhoads, D.C., Smith, C., Michaud, E., Parry, D., Wenzhöfer, F., Kennedy, B., Henriques, C., Battle, E., Carey, D., Iocco, L., Valente, R., Watson, J. & Rosenberg, R. 2003. Towards a greater understanding of pattern, scale, and process in marine benthic systems: a picture is worth a thousand worms. *Journal of Experimental Marine Biology and Ecology* **285–286**, 313–338.
- Solan, M. & Kennedy, R. 2002. Observation and quantification of *in-situ* animal-sediment relations using time lapse sediment profile imagery (t-SPI). *Marine Ecology Progress Series* **228**, 179–191.
- Solan, M., Mayor, D.J., Murray, L., Paton, G.I. & Killham, K. 2008. Coastal assimilative capacity for amalgamated fish farm chemicals/organic inputs. Final report on grant SARF009, Scottish Aquaculture Research Forum, UK. Available HTTP: http://www.sarf.org.uk/Project%20Final%20Reports/SARF009_Final%20Report.pdf (accessed 16 February 2011).
- Solan, M. & Wigham, B.D. 2005. Biogenic particle reworking and bacterial-invertebrate interactions in marine sediments. In *Coastal and Estuarine Studies 60, Interactions between Macro- and Microorganisms in Marine Sediments*, E. Kristensen et al. (eds). Washington, DC: American Geophysical Union, 105–124.
- Solan, M., Wigham, B.D., Hudson, I.R., Coulon, C.H., Kennedy, R., Norling, K., Nilsson, H. & Rosenberg, R. 2004b. *In situ* quantification of infaunal bioturbation using fluorescent sediment profile imaging (f-SPI), luminophore tracers and model simulation. *Marine Ecology Progress Series* **271**, 1–12.
- Soster, F.M. & McCall, P.L. 1990. Benthos response to disturbance in western Lake Erie: field experiments. *Canadian Journal of Fisheries and Aquatic Sciences* **47**, 1970–1985.
- Spight, T.M. 1976. Just another benthic study. *Ecology* **57**, 622–623.
- Stachowitsch, M. 1984. Mass mortality in the Gulf of Trieste: the course of community destruction. *Marine Ecology* **5**, 243–264.
- Strayer, D.L., Malcom, H.M., Bell, R.E., Carbotte, S.M. & Nitsche, F.O. 2006. Using geophysical information to define benthic habitats in a large river. *Freshwater Biology* **51**, 25–38.
- Teal, L.R., Bulling, M.T., Parker, E.R. & Solan, M. 2008. Global patterns of bioturbation intensity and the mixed depth of marine soft sediments. *Aquatic Biology* **2**, 207–218.
- Teal, L.R., Parker, E.R., Fones, G. & Solan, M. 2009. Simultaneous determination of *in situ* vertical transitions of colour, porewater metals and visualisation of infaunal activity in marine sediments. *Limnology and Oceanography* **54**, 1801–1810.
- Teal, L.R., Parker, E.R. & Solan, M. 2010. Sediment mixed layer as a proxy for benthic ecosystem process and function. *Marine Ecology Progress Series* **414**, 27–40.
- Tenore, K.R., Boyer, L.F., Cal, R.M., Corral, J., Garcia-Fernandez, C., Gonzalez, N., Gonzalez-Gurriaran, E., Hanson, R.B., Iglesias, J., Krom, M., Lopez-Jamar, E., McClain, J., Pamatmat, M.M., Perez, A., Rhoads, D.C., de Santiago, G., Tietjen, J., Westrich, J. & Windom, H.L. 1982. Coastal upwelling in the Rias Bajas, NW Spain: contrasting the benthic regimes of the Rias de Arosa and de Muros. *Journal of Marine Research* **40**, 701–772.
- Thomson, J., Brown, L., Nixon, S., Cook, G.T. & MacKenzie, A.B. 2000. Bioturbation and holocene sediment accumulation fluxes in the north-east Atlantic (Benthic Boundary Layer Experiment sites). *Marine Geology* **169**, 21–39.
- Tracey, G.A., Rhoads, D.C. & Carey, D.A. 2000. Application of *in situ* UV spectrometry for characterization of harbour sediment. Report by Science Applications International Corporation. DAMOS Contribution No. 127. Concord, Massachusetts: US Army Corps of Engineers, New England District.
- Valente, R.M. 1998. August 1998 REMOTS® survey of Historic Area Remediation Site (HARS) cells 1, 2 and 3. Newport, Rhode Island: Science Applications International Corporation Report No. 451 prepared for the U.S. Army Corps of Engineers, New York District.
- Valente, R.M. 2004. The role of seafloor characterization and benthic habitat mapping in dredged material management: a review. *Journal of Marine Environmental Engineering* **7**, 185–215.
- Valente, R.M. 2006. Response of benthic infauna and epifauna to ocean disposal of red clay dredged material in the New York Bight: a study using sediment-profile imaging, surface imaging and traditional methods. *Journal of Marine Systems* **62**, 173–188.
- Valente, R.M., Carey, D.A., Esten, M.E., Woods, C.R. & Berman, G.A. 2007. Application of four candidate habitat classification schemes for coastal and marine environments in Massachusetts. Newport, Rhode Island: Final report prepared for Massachusetts Office of Coastal Zone Management, Boston, MA.

- Valente, R.M. & Cuomo, C. 2005. Did multiple sediment-associated stressors contribute to the 1999 lobster mass mortality event in western Long Island Sound, USA? *Estuaries* **28**, 529–540.
- Valente, R.M., Evans, N.C. & Whiteside, P.G.D. 1996. Environmental monitoring in Hong Kong using the REMOTS seabed camera. *Coastal Management in Tropical Asia* **6**, 26–29.
- Valente, R.M. & Fredette, T.J. 2002. Benthic recolonization of a capped dredged material mound at an open water disposal site in Long Island Sound. In *Dredging '02. Key Technologies for Global Prosperity. Proceedings of the Third Specialty Conference on Dredging and Dredged Material Disposal, May 5–8, 2002, Orlando, Florida* [CD], S. Garbaciak, Jr. (ed.). New York: American Society of Civil Engineers, 46–51.
- Valente, R.M., Hung, H., McChesney, S. & Hodgson, G. 1998a. An investigation of benthic recolonization at a back-filled marine borrow pit in Hong Kong. In *Proceedings of the Third International Conference on the Marine Biology of the South China Sea*, B. Morton (ed.). Hong Kong: Hong Kong University Press, 489–507.
- Valente, R.M., McChesney, S.M. & Hodgson, G. 1999. Benthic recolonization following cessation of dredged material disposal in Mirs Bay, Hong Kong. *Journal of Marine Environmental Engineering* **5**, 257–288.
- Valente, R.M., McDowell, S.E. & May, B. 1998b. Monitoring of the 1997 Category II Capping Project at the New York Mud Dump Site. In *Proceedings of the Fifteenth World Dredging Congress*, R.E. Randall (ed.). Vancouver, Washington: Western Dredging Association, 835–849.
- Valente, R.M. & Pinckard, N. 2003. Results of 2002 REMOTS surveys to evaluate the effects of trawling on soft-bottom habitat in Massachusetts Bay. Newport, Rhode Island: Science Applications International Corporation Report No. 634 prepared for CR Environmental, East Falmouth, MA.
- Valente, R.M., Rhoads, D.C., Germano, J.D. & Cabelli, V.J. 1992. Mapping of benthic enrichment patterns in Narragansett Bay, Rhode Island. *Estuaries* **15**, 1–17.
- Valente, R.M. & Tufts, G. 2001. November 2000 REMOTS® survey at two candidate dredged material disposal sites in Buzzards Bay. Newport, Rhode Island: Science Applications International Corporation SAIC Report No. 548 submitted to the Massachusetts Office of Coastal Zone Management, Boston, MA.
- Valente, R.M., Waddington, T., Infantino, J. & Tufts, G. 2001. Palos Verdes Shelf pilot capping: use of side-scan sonar, sediment-profile imaging and planview photography for resolving cap material distribution and thickness. In *Proceedings of the Western Dredging Association Twenty-First Technical Conference*, R.E. Randall (ed.). College Station, Texas: Texas A&M University, Civil Engineering Department, 381–409.
- Vopel, K., Giles, H. & Zeldis, J. 2007. Colourful seafloor. *Water and Atmosphere* **15**, 22–23.
- Wang, Z., Matsuoka, K., Qi, Y., Chen, J. & Lu, S. 2004. Dinoflagellate cyst records in recent sediments from Daya Bay, South China Sea. *Phycological Research* **52**, 396–407.
- Weisberg, S.B., Ranasinghe, J.A., Dauer, D.M., Schaffner, L.C., Diaz, R.J. & Frithsen, J.B. 1997. An estuarine benthic index of biotic integrity (B-IBI) for Chesapeake Bay. *Estuaries* **20**, 149–158.
- Wenzhöfer, F. & Glud, R. 2004. Small-scale spatial and temporal variability in coastal benthic O₂ dynamics: effects of fauna activity. *Limnology and Oceanography* **49**, 1471–1481.
- Wheatcroft, R.A., Olmez, I. & Pink, F.X. 1994. Particle bioturbation in Massachusetts Bay: preliminary results using a new deliberate tracer technique. *Journal of Marine Research* **52**, 1129–1150.
- Whitlatch, R.B. 1974. Food-resource partitioning in the deposit feeding polychaete *Pectinaria gouldii*. *Biological Bulletin* **147**, 227–235.
- Wilber, D.H., Ray, G.L., Clarke, D.G. & Diaz, R.J. 2008. Responses of benthic infauna to large-scale sediment disturbance in Corpus Christi Bay, Texas. *Journal of Experimental Marine Biology and Ecology* **365**, 13–22.
- Wildish, D.J., Hargrave, B.T., MacLeod, C. & Crawford, C. 2003. Detection of organic enrichment near finfish net-pens by sediment profile imaging at SCUBA-accessible depths. *Journal of Experimental Marine Biology and Ecology* **285**, 403–413.
- Wildish, D.J., Hughes-Clarke, J.E., Pohle, G.W., Hargrave, B.T. & Mayer, L.M. 2004. Acoustic detection of organic enrichment in sediments at a salmon farm is confirmed by independent groundtruthing methods. *Marine Ecology Progress Series* **267**, 99–105.
- Wilson, S.J.K., Fredette, T.J., Germano, J.D., Blake, J.A., Neubert, P.L.A. & Carey, D.A. 2009. Plan-view photos, benthic grabs, and sediment-profile images: using complementary techniques to assess response to seafloor disturbance. *Marine Pollution Bulletin* **59**, 26–37.
- Wright, L.D., Schaffner, L.C. & Maa, J.P.-Y. 1997. Biological mediation of bottom boundary layer processes and sediment suspension in the lower Chesapeake Bay. *Marine Geology* **141**, 27–50.

- Young, D.K. & Rhoads, D.C. 1971. Animal-sediment relations in Cape Cod Bay, Massachusetts. I. A transect study. *Marine Biology* **11**, 242–254.
- Zajac, R.N. 2001. Organism-sediment relations at multiple spatial scales: implications for community structure and successional dynamics. In *Organism-Sediment Interactions*, J.Y. Aller, S.A. Woodin & R.C. Aller (eds). Columbia, South Carolina: University of South Carolina Press, 119–139.
- Zhu, Q., Aller, R.C. & Fan, Y. 2005. High-performance planar pH fluorosensor for two-dimensional pH measurements in marine sediment and water. *Environmental Science and Technology* **39**, 8906–8911.
- Zhu, Q., Aller, R.C. & Fan, Y. 2006. A new ratiometric, planar fluorosensor for measuring high resolution, two-dimensional $p\text{CO}_2$ distributions in marine sediments. *Marine Chemistry* **101**, 40–53.
- Ziebis, W., Huettel, M. & Forster, S. 1996. Impact of biogenic sediment topography on oxygen fluxes in permeable seabeds. *Marine Ecology Progress Series* **140**, 227–237.
- Zuur, A.F., Ieno, E.N. & Smith, G.M. 2007. *Analyzing Ecological Data*. New York: Springer-Verlag.

